

HUMAN RHYTHM COMPOSER

R-5

OWNER'S MANUAL

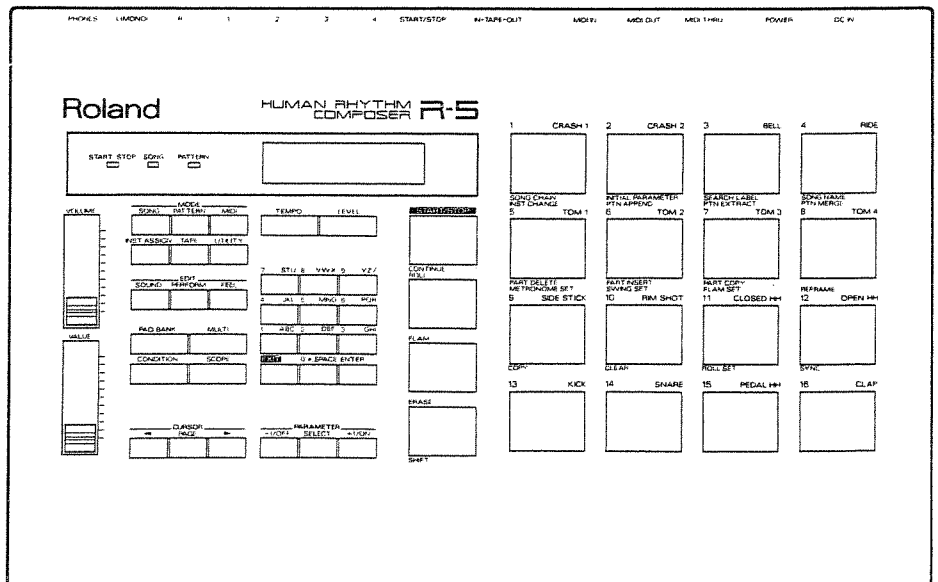

Apparatus containing Lithium batteries

ADVARSEL!

Lithiumbatteri – Eksplosionsfare ved fejlagtig håndtering.
Udskiftning må kun ske med batteri af samme fabrikat og type.
Levér det brugte batteri tilbage til leverandøren.

VARNING!

Explosionsfara vid felaktigt batteribyte.
Använd samma batterityp eller en ekvivalent typ som rekommenderas av apparatillverkaren.
Kassera använt batteri enligt fabrikantens instruktion.

ADVARSEL!

Lithiumbatteri – Eksplosjonsfare.
Ved utskifting benyttes kun batteri som anbefalt av apparatfabrikanten.
Brukt batteri returneres apparatleverandøren.

VAROITUS!

Paristo voi räjähtää, jos se on virheellisesti asennettu.
Vaihda paristo ainoastaan laitevalmistajan suosittelemaan tyyppiin. Hävitä käytetty paristo valmistajan ohjeiden mukaisesti.

Bescheinigung des Herstellers/Importeurs

Hiermit wird bescheinigt, daß der/die/das

ROLAND HUMAN RHYTHM COMPOSER R-5

(Gerät. Typ. Bezeichnung)

in Übereinstimmung mit den Bestimmungen der

Amtsbl. Vfg 1046/1984

(Amtsblattverfügung)

funk-entstört ist.

Der Deutschen Bundespost wurde das Inverkehrbringen dieses Gerätes angezeigt und die Berechtigung zur Überprüfung der Serie auf Einhaltung der Bestimmungen eingeräumt.

Roland Corporation Osaka/Japan

Name des Herstellers/Importeurs

RADIO AND TELEVISION INTERFERENCE

WARNING — This equipment has been verified to comply with the limits for a Class B computing device, pursuant to Subpart J, of Part 15, of FCC rules. Operation with non-certified or non-verified equipment is likely to result in interference to radio and TV reception.

The equipment described in this manual generates and uses radio frequency energy. If it is not installed and used properly, that is, in strict accordance with our instructions, it may cause interference with radio and television reception. This equipment has been tested and found to comply with the limits for a Class B computing device in accordance with the specifications in Subpart J, of Part 15, of FCC Rules. These rules are designed to provide reasonable protection against such a interference in a residential installation. However, there is no guarantee that the interference will not occur in a particular installation. If this equipment does cause interference to radio or television reception, which can be determined by turning the equipment on and off, the user is encouraged to try to correct the interference by the following measure:

- Disconnect other devices and their input/output cables one at a time. If the interference stops, it is caused by either the other device or its I/O cable. These devices usually require Roland designated shielded I/O cables. For Roland devices, you can obtain the proper shielded cable from your dealer. For non Roland devices, contact the manufacturer or dealer for assistance.
- If your equipment does cause interference to radio or television reception, you can try to correct the interference by using one or more of the following measures.
 - Turn the TV or radio antenna until the interference stops.
 - Move the equipment to one side or the other of the TV or radio.
 - Move the equipment farther away from the TV or radio.
 - Plug the equipment into an outlet that is on a different circuit than the TV or radio. (That is, make certain the equipment and the radio or television set are on circuits controlled by different circuit breakers or fuses.)
 - Consider installing a rooftop television antenna with coaxial cable lead-in between the antenna and TV. If necessary, you should consult your dealer or an experienced radio/television technician for additional suggestions. You may find helpful the following booklet prepared by the Federal Communications Commission: "How to Identify and Resolve Radio — TV Interference Problems"

This booklet is available from the U.S. Government Printing Office, Washington, D.C., 20402, Stock No. 004-000-00345-4.

CLASS B

NOTICE

This digital apparatus does not exceed the Class B limits for radio noise emissions set out in the Radio Interference Regulations of the Canadian Department of Communications.

CLASSE B

AVIS

Cet appareil numérique ne dépasse pas les limites de la classe B au niveau des émissions de bruits radioélectriques fixés dans le Règlement des signaux parasites par le ministère canadien des Communications.

R-5 Quick Operation Mode Table

■ Main Mode

● SONG

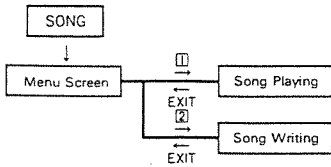

● PATTERN

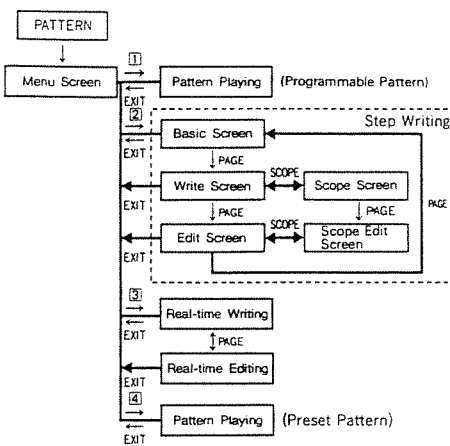

● MIDI

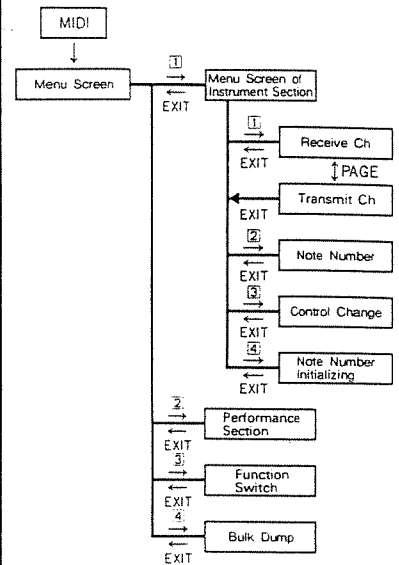

● Instrument Assignment

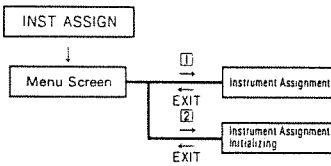

● TAPE

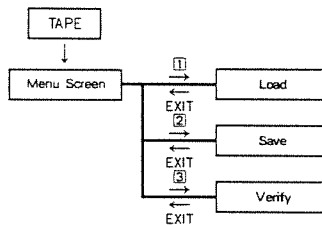

● Utility

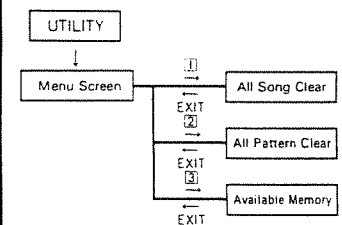

■ Edit Mode

● Sound Editing

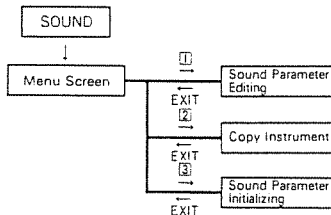

● Performance Editing

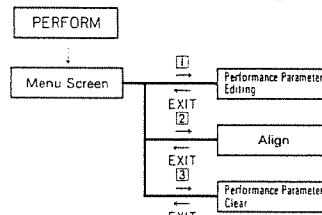

● Feel Editing

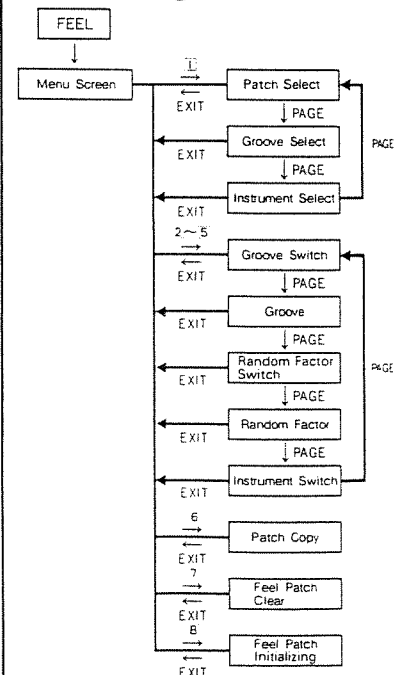

■ Data Flow of each Parameters

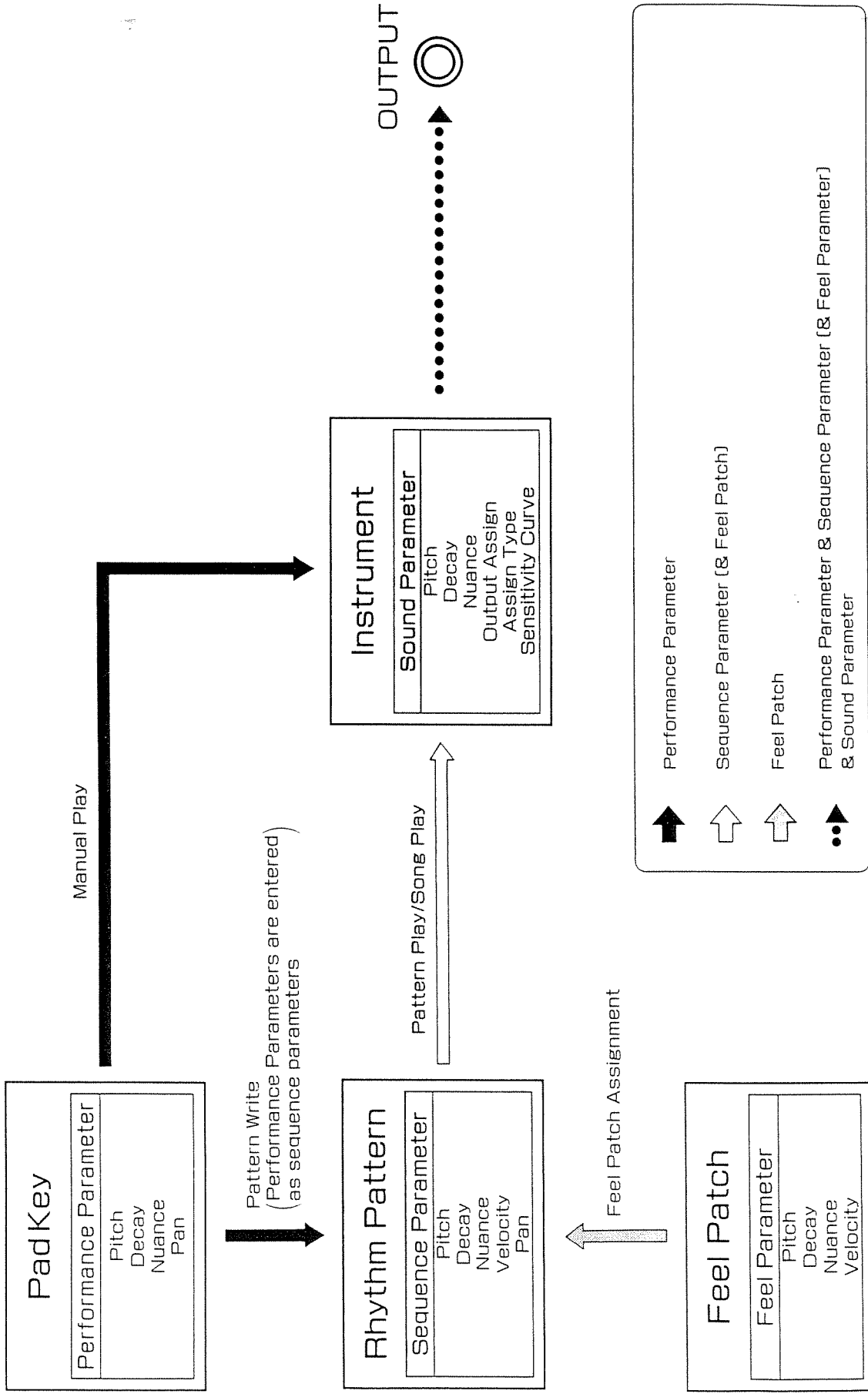

Instrument Table

INST#	DISPLAY	INSTRUMENT NAME
* 1	DRY_K1	DRY KICK 1
* 2	DRY_K2	DRY KICK 2
* 3	WOOD_K	WOOD KICK
* 4	DBL_K1	DOUBLE HEAD KICK 1
* 5	DBL_K2	DOUBLE HEAD KICK 2
* 6	SOLID	SOLID KICK
* 7	ROOMK1	ROOM AMBIENT KICK 1
* 8	ROOMK2	ROOM AMBIENT KICK 2
* 9	MONDO	MONDO KICK
* 10	ELE_K	ELECTRONIC KICK
* 11	WOOD_S	WOOD SNARE
* 12	OPEN_S	OPEN SNARE
* 13	TIGHT	TIGHT SNARE
* 14	FAT_S	FAT SNARE
* 15	IMPC_S	IMPACT SNARE
* 16	JAZZ_S	JAZZ SNARE
* 17	OUCH_S	OUCH! SNARE
* 18	RVB_S	REVERB SNARE
* 19	RIM_S1	RIM SHOT SNARE 1
* 20	RIM_S2	RIM SHOT SNARE 2
* 21	RIM_S3	RIM SHOT SNARE 3
* 22	ELE_S	ELECTRONIC SNARE
* 23	BR_HIT	BRUSH HIT SNARE
24	BR_ROL	BRUSH ROLL SNARE
25	SIDSTK	SIDE STICK
* 26	DRY_T1	DRY TOM 1
* 27	DRY_T2	DRY TOM 2
* 28	DRY_T3	DRY TOM 3
* 29	ROOMT1	ROOM AMBIENT TOM 1
* 30	ROOMT2	ROOM AMBIENT TOM 2
* 31	ROOMT3	ROOM AMBIENT TOM 3
* 32	ELE_T1	ELECTRONIC TOM 1
* 33	ELE_T2	ELECTRONIC TOM 2
* 34	ELE_T3	ELECTRONIC TOM 3
* 35	JAZZT1	JAZZ TOM 1
* 36	JAZZT2	JAZZ TOM 2
* 37	JAZZT3	JAZZ TOM 3
* 38	FX_T	FX TOM
* * 39	CLSD_H	CLOSED HIHAT
* * 40	OPEN_H	OPEN HIHAT
41	PDAL_H	PEDAL CLOSED HIHAT
42	CRSH_C	CRASH CYMBAL
* * 43	MLLT_C	MALLET CRASH CYMBAL
* * 44	RIDE_C	RIDE CYMBAL
* * 45	RDBL_C	RIDE BELL CYMBAL
46	BELL_C	RIDE CYMBAL BELL
47	808CLP	808 HAND CLAP
48	TIMBAL	TIMBALE
49	CLAVES	CLAVES
50	CABASA	CABASA

INST#	DISPLAY	INSTRUMENT NAME
51	COWBEL	COWBELL
52	TAMBRN	TAMBOURINE
53	SHAKER	SHAKER
54	MUT_CG	MUTE HIGH CONGA
55	SLP_CG	SLAP HIGH CONGA
56	OPN_CG	OPEN LOW CONGA
57	AGOGO	AGOGO
58	WHISTL	WHISTLE
59	BONGO	BONGO
* * 60	CAN	CAN
* 61	SURDO	SURDO
* * 62	BLAST	BLAST
* * 63	BACK_S	BACK SNARE
64	BACK_C	BACK CYMBAL
* 65	FING_B	FINGER BASS
* 66	SLAP_B	SLAP BASS
* 67	ACO_B	ACOUSTIC BASS
68	REST	REST

COPY INST#	SOURCE INSTRUMENT	
	INST#	INSTRUMENT NAME
* 1	28	DRY TOM 3
* 2	31	ROOM AMBIENT TOM 3
* 3	34	ELECTRONIC TOM 3
* 4	37	JAZZ TOM 3
* 5	38	FX TOM
* 6	38	FX TOM
* * 7	39	CLOSED HIHAT
* * 8	39	CLOSED HIHAT
* * 9	40	OPEN HIHAT
* * 10	40	OPEN HIHAT
11	42	CRASH CYMBAL
12	42	CRASH CYMBAL
13	42	CRASH CYMBAL
14	47	808 HAND CLAP
15	48	TIMBALE
16	50	CABASA
17	51	COWBELL
18	56	OPEN LOW CONGA
19	57	AGOGO
20	59	BONGO
* * 21	40	OPEN HIHAT
22	58	WHISTLE
23	49	CLAVES
24	47	808 HAND CLAP
25	53	SHAKER
* 26	66	SLAP BASS

* The sound changes by changing the strength of Pad Key hitting or the setting of Nuance.
 ** The sound changes by changing the setting of Nuance.

■Parameter Table

Parameter	Sound Parameter		Performance Parameter		Feel Parameter		Sequence Parameter	
	Display	Value Range	Display	Value Range	Display	Value Range	Display	Value Range
Velocity	---	---	---	---	VELO	-99~+99	VL	1~127
Pitch	PITCH	-4800~+4800	PITCH	-4800~+4800	PITCH	-99~+99	PT	-4800~+4800
Decay	DECAY	0~127	DECAY	-63~+63	DECAY	-99~+99	DC	-63~+63
Nuance	NUANCE	0~15	NUANCE	-7~+7	NUANCE	-7~+7	NU	-7~+7
Output Assign (Pan)	OUTPUT	LEFT 1~3/CENTER/ RIGHT 1~3/MULTI 1~4	PAN	OFF/LEFT 1~3/ CENTER/RIGHT 1~3	---	---	PN	OFF/L 1~3/C/R 1~3
Assign Type	ASSIGN	POLY/MONO/EXC 1~8	---	---	---	---	---	---
Sensitivity Curve	CURVE	1~8	---	---	---	---	---	---

R-5 HUMAN RHYTHM
COMPOSER

GUIDEBOOK

Roland

This Guidebook is intended for those who are using a rhythm machine for the first time.

It provides explanation of the basic procedures required to operate the R-5 and the steps that should be taken to create rhythms.

After giving you an opportunity to audition the demonstrations and preset patterns the R-5 offers, you will be guided through the actual creation of rhythm patterns using a few simple musical examples.

Please note that this guidebook does not attempt to cover all the functions available with the R-5. For detailed explanation, refer to the Owner's Manual.

■ CONTENTS

■ Before Starting	4
① Let's have a listen	6
1. Using the Pad Keys to produce sound	7
2. Demonstration Play	8
3. Play using a Feel Patch	9
② Creation of a rhythm	11
1. The process of rhythm creation	11
2. Making a rhythm pattern	12
a. Using Real-time Write	14
b. Using Step Write	24
3. Arranging rhythm patterns to create a song	35

Copyright © 1989 by ROLAND CORPORATION

All rights reserved. No part of this publication may be reproduced in any form without the written permission of ROLAND CORPORATION.

■ Before Starting

- In this guidebook, buttons are indicated as they actually appear above the unit's buttons, such as **SONG** . (For panel descriptions, refer to the Owner's Manual, p. 11.)
- Parameters on the R-5 are set by means of **-1/OFF** , **+1/ON** , the Numerical Keys, and the VALUE slider. Within this guidebook, certain controls may be explained in an abbreviated form. For details, refer to the Owner's Manual, page 19.

[Connections]

With the power off, connect up the R-5 as shown below:

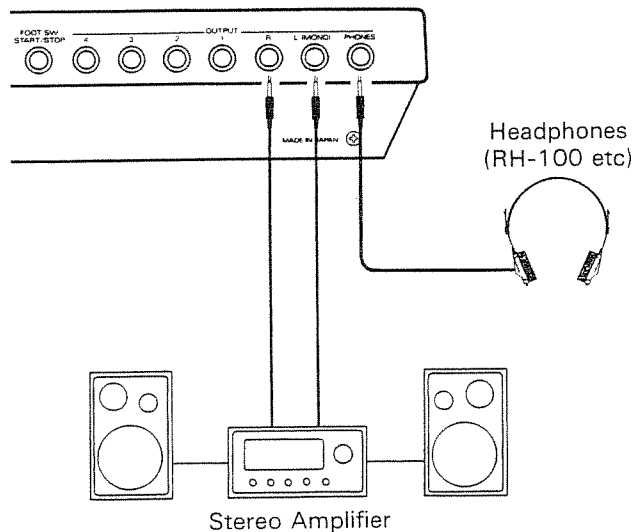

- * By employing Multi Output Jacks 1 through 4, any particular instrument of your choice can be output from a specific jack. When leaving the factory, however, the unit is set to provide output of all instruments from the Stereo Output, so no sound is obtained from the Multi Output Jacks. To use the Multi Output Jacks, you will need to make changes using Output Assign(See Owner's Manual page 96).

【Initialize】 See [Initialize] page 129 in Owner's Manual.

To be sure all procedures outlined here will match your unit, return the R-5 to its factory settings. This is referred to as *initialization*.

With the power off, press and hold both **SELECT** and **PAGE**, then turn on the power. Your display should show the following:

```
SYSTEM INIT  
Press ENTER.
```

Press **ENTER** twice to perform initialization.

*If you do not wish to initialize, simply turn the power switch on.

1 Let's have a listen

Before getting into creation of rhythms, you should first check out the instruments (rhythm sounds) available internally with the R-5.

1. Using the Pad Keys to produce sound

- 1 Move the **VOLUME** slider up to an appropriate position.

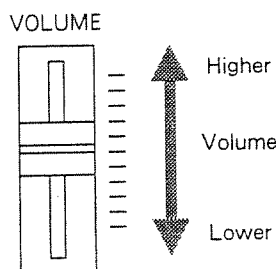

- 2 When you now tap any of the Pad Keys, the instrument assigned to that Pad Key will sound. The volume will change depending on how hard you tap. (With instruments indicated by "*" in the chart on page 185 in the Owner's Manual, the tone will also change slightly depending on how hard you tap.)

* You can obtain the best control over volume change by tapping at the lower part of the Pad Key. Also, make sure to use only your fingers.

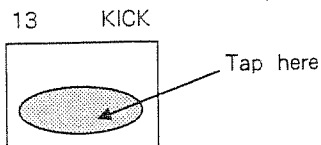

- To obtain a flam effect, press down **FLAM** while tapping the Pad Key.
- Likewise, a roll effect can be gotten by holding down **ROLL** while tapping a Pad Key. As long as the Pad Key is pressed, the sound will continue, at predetermined intervals. Also, the strength of the press will cause change in volume.

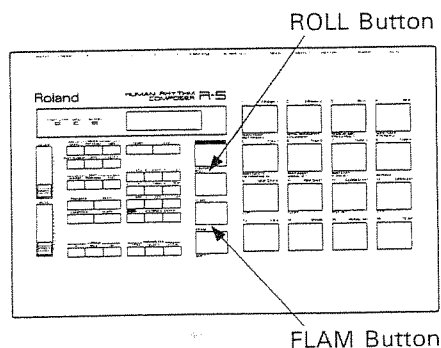

* To change the settings controlling Flam or Roll, refer to pages 34, in the Owner's Manual.

[Changing the Pad Bank]

A total of 80 different instruments can be assigned to the Pad Keys at any time. Each set of 16 instruments assigned to the 16 Pad Keys is called a Pad Bank. There are 5 Pad Banks (A through E) which you can use for selection.

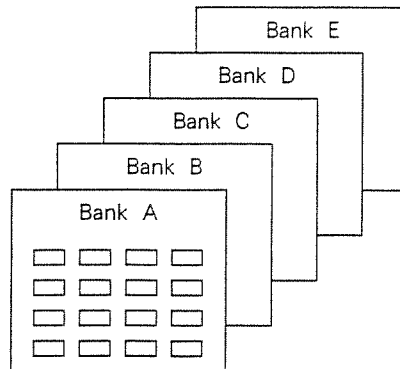

Each press of **PAD BANK** provides selection in revolving order of the Pad Banks.

To check which Pad Bank is currently selected, press **CONDITION**.

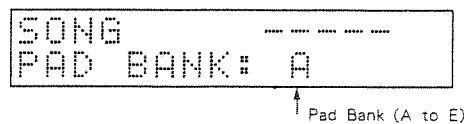

Press **CONDITION** once again, and you are returned to the original display.

* See page 122 in the Owner's Manual for explanation of functions offered with **CONDITION**.

* See page 189 in the Owner's Manual for the default Pad Bank settings.

* Should you wish to change the instruments sounded by certain Pad Keys, and perhaps use an instrument not yet assigned to any Pad Key, you can change the assignment for instruments. (See Owner's Manual, p. 88)

2. Demonstration Play

Included in the factory settings is a demonstration song. The following procedure will allow you to listen to this demonstration.

- ① Press **SONG** to enter the Song mode.

The Song Indicator will light, and the Menu screen will be displayed.

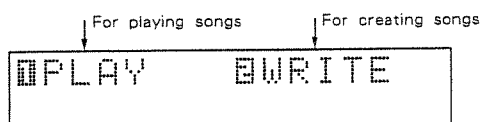

In the Menu screen there will be displayed the names of the functions which can be performed from that mode.

* If the Menu screen does not appear, press **EXIT**.

- ② Press **1** in the Numerical Keys to select "PLAY".

You now are at the screen used for playing songs.

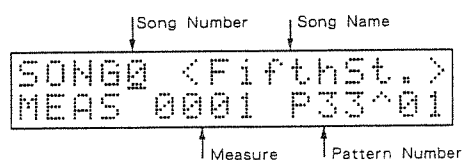

The demonstration song is in memory at the Song Number 0 position.

- ③ Press Numerical Key **0** to select the demonstration song.

- ④ Press **START/STOP** and the song will start playing.

The Tempo Indicator blinks for each beat, and the display indicates the information of play in progress.

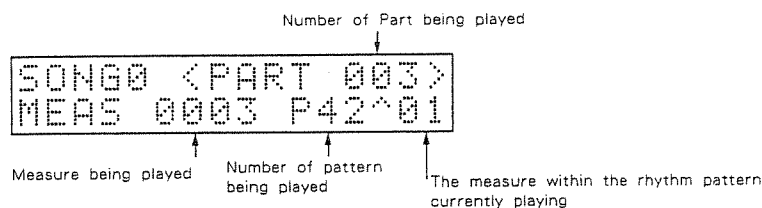

- ⑤ Press **START/STOP** once again, and the song stops playing.

If you hold down **SHIFT** while pressing **START/STOP**, you will be able to start play beginning from where you stopped last.

3. Play using a Feel Patch

Next, try listening to the performance using a Feel Patch, one of the R-5 features.

- ① Press **PATTERN** to enter the Pattern mode.

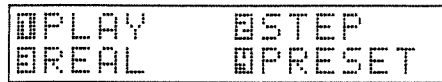

- ② Press Numerical Key **1** to select "PLAY".

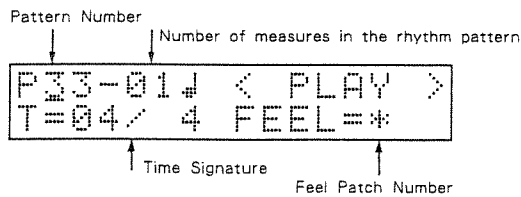

This screen normally is used to play rhythm patterns you have created, but at the factory default settings, there will be Preset Patterns that have been copied to pattern numbers 00 - 31. Here, we will use these rhythm patterns to get a grasp of the effects obtained with a Feel Patch.

- ③ Using the Numerical Keys, select the pattern numbers from the chart below.

Pattern Number	Type of Rhythm Pattern	Feel Patch Number
00 01	8 Beat	0, 1
04 05	16 Beat	2, 3, 4
09 10	Shuffle	5, 6
19	Swing	7

- ④ First, press **START/STOP** and listen to the rhythm pattern before a Feel Patch is assigned.

- ⑤ Stop play, and with **▶** position the cursor (the lower bar, “_”) so that it appears at the place for setting the value of “FEEL=”.

- ⑥ Enter the number of the Feel Patch using the Numerical Keys.

Refer to the chart in ③ , and select a Feel Patch suitable for the rhythm pattern.

- ⑦ Press **START/STOP** to start play.

Once a Feel Patch has been assigned, you will be able to hear the natural expression enhancing the performance. Try changing to another patch to experience the difference.

Through repeating steps ③ through ⑦ , try out the effect with other rhythm patterns as well.

2 *Creation of a rhythm*

In this section, you will be guided through actual creation of a rhythm pattern, and an explanation of the procedural steps.

If you have so far made any changes in the Instrument Assignments, or settings for Flam/Roll, you should here once again carry out initialization as explained on p. 5.

*In this guidebook, the explanation assumes use of Pad Bank A, but if you so wish, any other Pad Bank, from A to D can be used as well.

1. The process of rhythm creation

On the R-5, a number of individually created rhythm patterns, each consisting of a number of measures, are built first. This is referred to as Pattern Write. Up to a maximum of 100 rhythm patterns can be stored in the unit. The desired rhythm patterns are then linked together in the order in which they are to be played; a process called Song Write. A maximum of 6 songs can be created.

2. Making a rhythm pattern

The following piece will be used in creating rhythms.

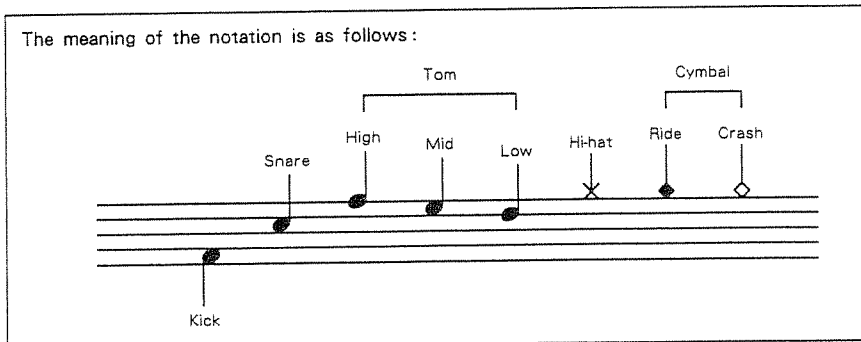

Section A and B of the musical score. Section A consists of two measures of music. Section B consists of eight measures of music, each containing a sequence of drum hits (represented by 'x' marks) and a melodic line. The notation is in 4/4 time.

Section C and D of the musical score. Section C consists of four measures of music, including a cymbal crash (open diamond) in the third measure. Section D consists of four measures of music, each containing a sequence of drum hits and a melodic line.

Section D and E of the musical score. Section D consists of four measures of music, each containing a sequence of drum hits and a melodic line. Section E consists of two measures of music, each containing a sequence of drum hits and a melodic line.

【Divide into rhythm patterns】

First decide on how many patterns the piece is to be divided into.

Since on the R-5 up to 99 measures can be included in one rhythm pattern, it is not impossible to put all the rhythms in this score into one rhythm pattern. However, when you consider the resulting lack of efficiency with the Pattern Writing process, or the trouble that may arise when trying to make minor corrections, you can see that it is after all best to divide it up into a number of rhythm patterns.

Ordinarily, one rhythm pattern would consist of from 1 to 2 measures. But when several measures together make up one phrase, they are included in 1 rhythm pattern.

For our purposes here, we will divide the piece into 5 rhythm patterns, A to E, as indicated in the score.

【Inputting a rhythm pattern】

For entering patterns, two methods are available. You can either tap the Pad Keys in time to the metronome, which is input directly (Real-time Write), or specify one by one the timing at which sound is to be produced for each instrument (Step Write).

To work using Real-time Write, follow the steps from next page.
To input using Step Write, read from page 24.

a. Using Real-time Write

With play stopped, press **PATTERN** to chose the Pattern mode.

The Pattern Indicator will light, and the following Menu will be displayed.

```

PLAY  STEP
REAL  PRESET
  
```

Press Numerical Key **3** to select "REAL". The Real-time Write screen will appear.

```

      ↓ Pattern Number
P00-01↓ < REAL >
T=04/ 4 Q=1/16 →
      ↑ Time Signature  ↑ Quantize
  
```

* When you are not sure where you are in terms of screens, **EXIT** can always be pressed to return to the Menus.

First, select the number of the pattern (00 - 99) where the rhythm pattern is to be made. Contained in pattern numbers 00 - 50 are the Preset Patterns and demonstration-use rhythm patterns. These patterns can be newly rewritten, but for purposes of explanation here, we will place rhythm patterns A to E at pattern numbers 90 through 94.

Now, follow along in order while creating the 5 patterns.

Rhythm Pattern A

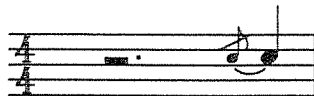

Press “90” in the Numerical Keys to select pattern number 90.

[Set the time signature and number of measures]

The first items to set are the time signature and number of measures the rhythm pattern will have.

While holding down **SHIFT**, press Pad Key **10** (CLEAR).

```
PTN FORMAT <P90>
T= 04/ 4 BAR= 01
```

↑ Time Signature ↑ Number of measures

At this point you have the screen used to set the time signature and number of measures for a pattern you are about to make.

In the display you should see that the time signature is 4/4, and that there will be 1 measure. Since this is what we want for this pattern, you only need to press **ENTER**.

* As you may have noticed above, the Pad Keys have functions printed below each of them that are accessed by holding down **SHIFT**, and pressing the key for the desired function. Such Shift Functions can be used while in the Pattern and Song modes.

Press **START/STOP**.

The metronome will be audible, in quarter note. The unit is now ready for input of sound.

↓ Unit is ready to record in Real-time

```
F90^01* <+REC!!>
T=04/ 4 Q=1/16 +
```

When you wish to change the tempo, perform the following:

【Changing Tempo】

Press **TEMPO** to select the screen for setting tempo.

```
TEMPO ADJUST
  ♯ = 120
      ↑
    Setting for Tempo
```

Change the tempo using **-1/OFF** , **+1/ON** .

* A more rapid change of the value can be obtained by holding **+1/ON** (or **-1/OFF**) and pressing its counterpart, **-1/OFF** (or **+1/ON**). This feature is available in all cases where **-1/OFF** , **+1/ON** are used.

When changes have been completed, press **TEMPO** once again to return to the Real-time Write screen.

【Entering Flam】

Play the snare, with flam, as shown in the notation.

To add flam to a sound being input, hold down **FLAM** while hitting the Pad Key for the instrument you want.

Listen to the metronome, and while holding **FLAM** , tap the pad for the snare (14) on the 4th time signature.

The flammed snare thus has been entered.

After being input, a sound will repeat playing for the set number of measures.

Here, press **START/STOP** to stop play.

【Editing Flam】 See Owner's Manual, p. 34.

Next, try applying some editing to the flam.

With play stopped, hold down **SHIFT** while pressing Pad Key **7** (FLAM SET). You then will have the Flam Setting screen.

```
FLAM SET <P90>
$INTVL= 15
      ↑
    Flam Interval
```

At present, the Flam Interval (interval between the first and second hits of the flam) is set to 15. Using **-1/OFF** , **+1/ON** , change this value to 10, then press **ENTER** .

If you now press **START/STOP** and listen, you should be able to hear the difference in the effect of the flam.

Try experimenting with a variety of settings for the interval, until you find what you like. For Flam, in addition to the Flam interval, there is also another parameter, Flam Ratio (the ratio between volume of first and second hits).

The Flam Ratio parameter can be selected by pressing **SELECT** from the Flam Setting screen.

```
FLAM SET <P90>
$RATIO=*1: 2*
```

*In all cases such as this, where the “\$” symbol is visible to the left of a parameter, you can change to another parameter by pressing **SELECT** .

* Whenever an item is inclosed with “ * ”, such as “ * 1:2 * ”, this means its value cannot be changed using the Numerical Keys.

Rhythm Pattern B

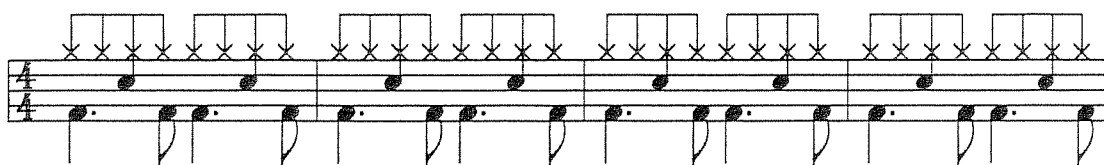

With play stopped, select pattern number 91 using **-1/OFF** , **+1/ON** .

Hold **SHIFT** while pressing Pad Key **10** (CLEAR), then set the time signature and number of measures for the pattern.

This pattern will have 4 measures, so use the Numerical Keys to input “04”, then press **ENTER** .

```
PTN FORMAT <P91>
T= 04/ 4 BAR= 04
```

Rhythm pattern B is a basic 8 time signature rhythm.

Press **START/STOP** to start the metronome.

First, play Pad Key **11** to enter the hi-hat in 8th notes for the 4 measures.

Next, hit Pad Key **14** on the 2nd and 4th time signatures of each measure to enter the snare. The kick (Pad Key **13**) should be entered by referring to the score. When finished, stop play.

[When you have made a mistake in the entry]

The procedures shown below can be used to erase, on a per instrument basis, sounds that have been input in a rhythm pattern. When a mistake has been made, erase the questionable part and re-enter it.

● **To erase all at once**

After stopping play, hold down **SHIFT** while pressing Pad Key **10** (CLEAR).

```
PTN CLEAR <P91>
INST=ALL
```

Next, select the instrument to be deleted using **-1/OFF**, **+1/ON**. Here, let's try erasing the hi-hat. Select "CLSD_H". When you then press **ENTER**, the sound of the hi-hat is gone, and you are returned to the Real-time Write screen. To cancel the procedure, press **EXIT**.

● **To erase while playing**

While in play, if you press a particular Pad Key while holding down **SHIFT**, the sound for that instrument will be erased only for the portions during which you have the pad pressed. Try this using the hi-hat. First enter any suitable pattern for the hi-hat. Then with play started hold down **SHIFT** and press the hi-hat Pad Key (**11**). You should thus be able to confirm that the sound has been erased from the pattern at the areas where you pressed the Pad Key.

Finally, input the hi-hat again so it matches the notation; and you're ready to start on the next pattern.

Rhythm Pattern C

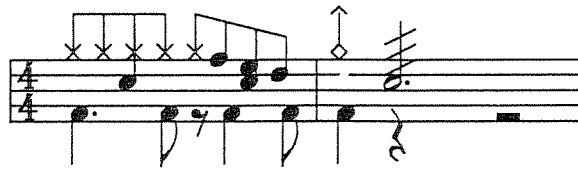

* For explanation of the notation, see p. 12.

With play stopped, select pattern number 92. This pattern will have 2 measures, so use the procedure already explained to set the number of measures at 2.

Press **START/STOP** to start the metronome.

First enter the pattern in the first measure. The measure for which sound is currently being input is indicated to the right of the pattern number in the display.

↓ Measure currently being input

```
P92^02* <+REC!!>
T=04/ 4 Q=1/16 +
```

First, enter the eighth notes for the hi-hat. Try to get a good solid rhythm in time with the metronome using Pad Key **11**. Enter the snare and the kick as well, as shown in the score. Then continue on with a tom fill (Pad Keys **6**, **7**, and **8**) to lead into the second measure. Then enter the crash cymbal and the kick on the first time signature of the second measure.



Any time you can't get quite what you want, simply erase it and try over again.

Finally, enter the snare with a Roll effect from the 2nd to the 4th time signatures in the second measure.



Currently, the interval for the Roll is set to 32nd notes. That is sufficient for our purposes here. Before entering the sound though, Quantize should be changed so you can use the Roll.

[Setting for Quantize]

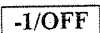
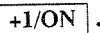
In Real-time Write, the resolution of the timing used for input of sounds can be controlled by settings for quantize. For example, with quantize set at 1/16, no matter how off you may be in your timing when entering notes, they will be entered correctly in 16th notes. Here we will set Quantize at 1/32 so it matches the intervals of the roll effect.



Using  , position the cursor at "Q=", then select 1/32 using , .

Before actually entering the roll, first try it out a while to get the feel of it.

With play stopped, hold  while pressing the snare Pad Key . The snare will be rolled for as long as the Pad Key is pressed. If you change the amount of pressure you apply on the pad, you will find this allows you to obtain changes in its volume.

When you're ready, enter the roll into the rhythm pattern.

Press .

While listening to the rhythm play, hold down . Then at the 2nd time signature in the second measure, press the snare Pad Key , and then release it just before the start of the first measure.

If not successful with the input, erase it and try again.

[Changing the pitch of sounds that have been input] See Owner's Manual, p. 58.

Next, using the Real-time Edit functions, let's change the pitch of the rolled snare you just entered. Real-time Edit allows you to make changes in the parameters of sounds that have been input, while you play the rhythm pattern. The parameters that can be changed are: Velocity (volume), Pitch, Decay (decay time), Nuance (timbre), and Pan (orientation).

First, try out a simple Real-time Editing procedure.

Press  in the Real-time Write screen to call the Real-time Edit screen.

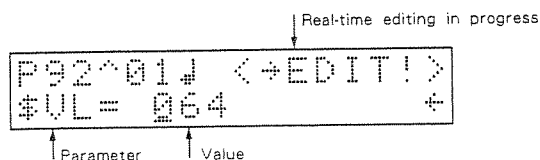

Press **SELECT** and choose “\$PT=0000”. Using the VALUE slider, set the Pitch to “-0500”. Start play, and during the portion where the snare was rolled, hold down Pad Key **14**.

You should then be able to confirm that the roll has decreased in pitch. To restore the pitch to what it was originally, set the value at 0000 and repeat the procedure.

Next, try applying continuous change to the pitch of the roll.

In Real-time Edit, through holding down a Pad Key while the VALUE slider is moved, you can make settings for the parameters on a continuing basis.

After setting the Pitch to a reasonable value with the VALUE slider, wait for the part where the snare is rolled, then while holding down the Pad Key, slowly move the VALUE slider upwards.

The pitch of the roll will change continuously.

When you are through with any editing, press **PAGE** once again to return to the Real-time Write screen.

Rhythm Pattern D

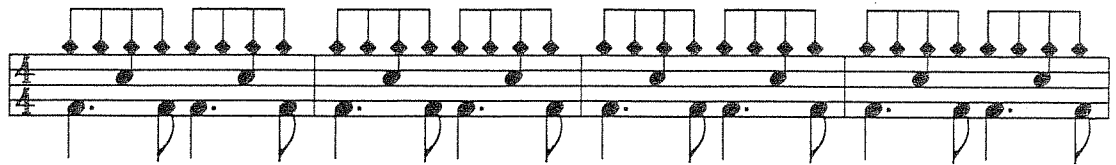

This rhythm pattern is very similar to pattern B, except that instead of the hi-hat, we have the ride cymbal. The kick and snare are exactly the same. So, here you can use the R-5's Pattern Copy and Instrument Change functions to make D based on B.

【Copying performance data】 See Owner's Manual, p. 54.

With play stopped, select pattern number 91 (rhythm pattern B). Then, while holding down **SHIFT**, press pad number 9 (COPY).

A Pattern Copy screen like below will appear:

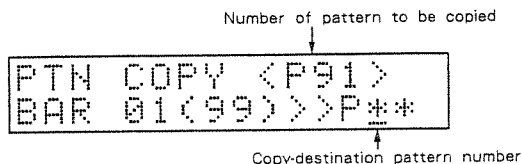

Use the Numerical Keys to enter 93, the number of the pattern that becomes the destination of the copy, and press **ENTER**. With this step, the performance data in pattern number 91 will have been copied to pattern number 93.

【Changing instruments】 See Owner's Manual, p. 48.

Next, using the Instrument Change function, the hi-hat in pattern number 93 will be changed to a ride cymbal.

Select rhythm pattern 93 using **-1/OFF**, **+1/ON**.

Next, while holding down **SHIFT**, press Pad Key **1** (INST CHANGE).

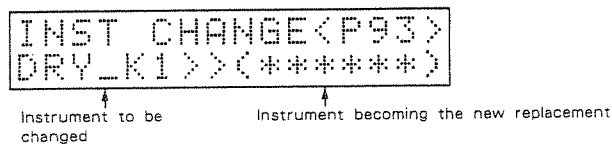

Using **-1/OFF**, **+1/ON** select "CLSD_H". Then press Pad Key **4** to specify "RIDE_C".

Press **ENTER**, and the hi-hat will be replaced by the ride cymbal.

Start play, and check that this has taken place.

【Changing the pan】

Next, as one more example of Real-time Editing, try editing the Pan for the ride cymbal.

Press **PAGE** and change to the Real-time Edit screen. Then use **SELECT** to choose “\$PN= * OFF * ”.

Start play, and while pressing Pad Key **4**, use the VALUE slider to gradually change the value from “L3” to “R3.”

The orientation of the ride cymbal will move from the left to the right.

Set it at the position you like best.

Rhythm Pattern E

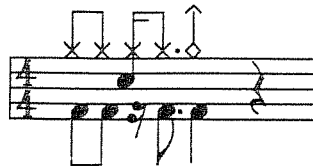

* For explanation of the notation, see p. 12.

Now comes the final rhythm pattern, which we will make at pattern number 94. The notation shows a pattern E for reference, but you might prefer to try something else.

Before entering the sound, check your setting for quantize. For rhythm pattern C it was set to 1/32, but if you have difficulty inputting sixteenth or eighth notes, change quantize to suit the rhythm pattern you are going to use.

Also, if you are going to use roll for the ending, set the Roll Interval to the same as Quantize, or set Quantize at a finer resolution than the Roll. Otherwise, if the value of quantize is not finer than that of Roll, you might not be able to input sounds the way you want them.

b. Using Step Write

In Step Write, each measure is divided into units called Steps. A rhythm pattern is created by specifying the timing of each note to be sounded (Step), for each instrument.

These Steps are numbered in order starting from the beginning of the measure.

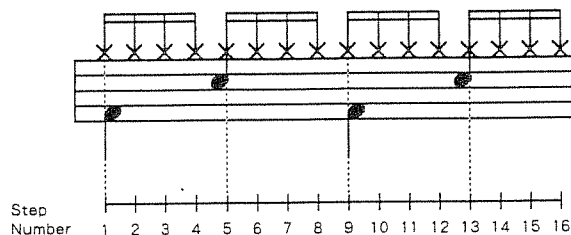

Here we will proceed with the making of rhythm patterns using Step Write.

With play stopped, press **PATTERN** to choose the Pattern mode.

The Pattern Indicator will light, and the following display will be appear:

```

PLAY    STEP
REAL    PRESET
    
```

* If the Menu screen does not appear, Press **EXIT**.

Press Numerical Key 2 to select "STEP". You will then be in the Step Write screen, as shown below.

```

Pattern Number
↓
P33-01 ↓ < STEP >
T=04 / 4 D=*NRM* ↵
↑
Time Signature
    
```

* Whenever you are unsure as to which screen is currently displayed, press **EXIT**.

You will always exit from any step along the way.

First, select the number (00 - 99) of the pattern where a rhythm pattern is to be created. Contained in pattern numbers 00 - 50 are the Preset Patterns and demonstration-use rhythm patterns. These patterns can be newly rewritten, but for purposes of explanation here, we will place rhythm patterns A to E at pattern numbers 90 through 94.

Rhythm Pattern A

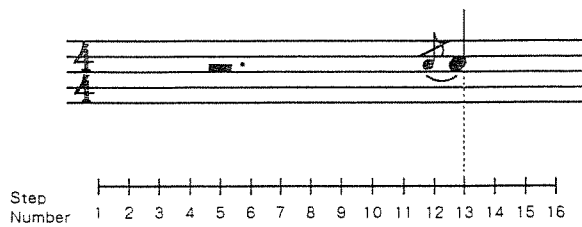

Press "90" in the Numerical Keys to select pattern number 90.

【Set the time signature and number of measures】

Next, set the time signature and number of measures the rhythm pattern will have.

While holding down **SHIFT**, press Pad Key **10** (CLEAR).

```
PTN FORMAT <P90>
T= 04/ 4 BAR= 01
```

↑ Time Signature ↑ Number of measure

Here you have the screen used to set the time signature and number of measures for a pattern you are about to make.

In the display you should see that the time signature is 4/4, and that there will be 1 measure. Since this is what we want for this pattern, you only need to press **ENTER**.

* As you may have noticed above, the Pad Keys have functions printed below each of them that are accessed by holding down **SHIFT**, and pressing the key for the desired function. Such Shift Functions can be used while in the Pattern and Song modes.

【Entering Flam】

Enter the snare, with flam, as shown in the notation.

With play stopped, press Pad Key **14** to select the snare. Next, press **START/STOP**. The Tempo Indicator will begin blinking, and the unit is ready for input of sound.

↓ Step Writing in progress

```
P90--01* <+REC!!>
T=04/ 4 D=*NRM*+
```

Now, when play is started, Pad Keys **1** through **16** become keys used for specifying the timing that sound will be produced. Currently, the length of one Step will be set to 16th notes. Thus, the timing of the 4th time signature would fall at Step 13.

Ordinarily, you would just hit Pad Key **13**. But since flam is desired, hold down **FLAM** while pressing Pad Key **13**.

Since the strength of your press on the pad is input as well, take notice of the accent you might give it.

The input sound will be played repeatedly, for the number of measures set for the rhythm pattern.

Press **START/STOP** to stop play.

[Editing Flam] See Owner's Manual, p. 34.

Next, try applying some editing to the flam that was input.

With play stopped, hold down **SHIFT** while pressing Pad Key **7** (**FLAM SET**). You then will have the Flam Setting screen.

```

FLAM SET <P90>
$INTUL= 15
          ↑
          Flam Interval
  
```

Currently, the Flam Interval (interval between first and second hit) will be set at 15. Using **-1/OFF**, **+1/ON** change this value to 10, then press **ENTER**.

If you now press **START/STOP** and listen, you should be able to hear the difference in the effect of the flam.

Try experimenting with a variety of settings for the interval, until you find what you like. For Flam, in addition to the Flam interval, there is also another parameter, Flam Ratio (the ratio between volume of first and second hits).

The Flam Ratio parameter can be selected by pressing **SELECT** from the Flam Setting screen.

```
FLAM SET <P90>
$RATIO=*1: 2*
```

* In all cases such as this, where the "\$" symbol is visible to the left of a parameter, you can change to another parameter by pressing **SELECT** .

* Whenever an item is inclosed with "*", such as "* 1 : 2 *", this means its value cannot be changed using the Numerical Keys.

Rhythm Pattern B

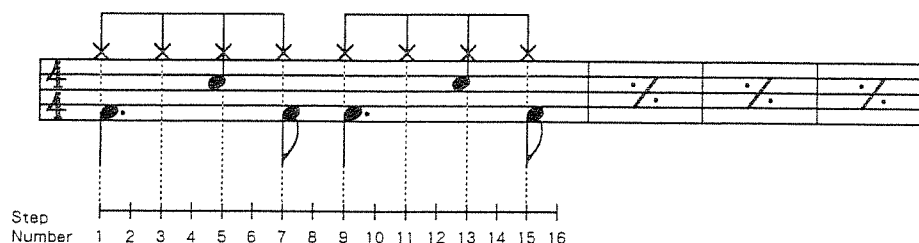

With play stopped, select pattern number 91 using **-1/OFF** , **+1/ON** .

Hold **SHIFT** while pressing Pad Key **10** (CLEAR), then set the time signature and number of measures for the pattern.

This pattern will have 4 measures, so use the Numerical Keys to input "04", then press **ENTER** .

```
PTN FORMAT <P91>
T= 04/ 4 BAR= 04
```

Rhythm pattern B is a basic 8 time signature rhythm.

Try inputting it starting with the first measure.

With play stopped, press Pad Key **11** to select the hi-hat.

Press **START/STOP** to get ready for sound input.

According to the score, the timing of the hi-hat puts it at Step Numbers 1, 3, 5, 7, 9, 11, 13, and 15. So, you should press all correspondingly numbered Pad Keys.

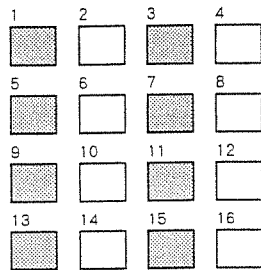

Then input the snare. Stop play for a moment and press the snare Pad Key **[14]**. Start play again, and hit Pad Keys **[5]** (2nd time signature) and **[13]** (4th time signature).

Next comes the kick. Stop play and press pad 13. Then when started again, hit Pad Keys **[1]**, **[7]**, **[9]**, and **[15]**.

Should you make a mistake and press the Pad Key for a different Step, you can erase the sound input there by pressing the same pad again.

When you have finished, stop play.

Next, the second measure will be input.

Before input of the 2nd measure in a pattern, use **[◀]** **[▶]** to move the cursor to the right of the pattern number, then set the measure number to "02" using **[-1/OFF]**, **[+1/ON]**.

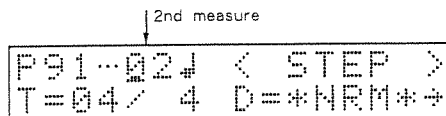

After pressing **[START/STOP]** to start the unit, it can then accept settings for the Steps of the second measure. The rhythm pattern is then input using the same procedures used for the first measure. The 3rd and 4th measures should also be input.

When you finished, stop play.

Rhythm Pattern C

* For explanation of the notation, see p. 12.

Step Number 1 2 3 4 5 6 7 8 9 10 11 12 13 14 15 16 1 2 3 4 5 6 7 8 9 10 11 12 13 14 15 16

With play stopped, use to move the cursor back to the position of the pattern number, and select pattern number 92. This rhythm pattern will have 2 measures. Using the same procedure as before, set the number of measures, this time to 2.

First, input the first measure.

Press Pad Key to select the hi-hat. Then start play, and press Pad Keys , , , , and . Refer to the Step Numbers for the snare, kick, and tom (Pad Keys , , and) on the score, and input them as well.

Continue on with measure two. This time, try doing it using the Write screen.

In Step Writing, in addition to the screen used so far (Basic screen), there is also a Write screen, and an Edit screen. The Write screen is similar to the Basic one, in that it is used for inputting sounds. But it also can be used for creating rhythms with unusual time signatures, or for using the Scope function to specify sound timing in 1/96 note units (See Owner's Manual, p.43). Additionally, the Edit screen can be used to edit the timbres of instruments that have been input.

[Input in the Write Screen] See Owner's Manual, p. 42.

With play stopped, move the cursor to the right of pattern number, and set the number of measures at 2.

Then press and you will see the Write screen, as below.

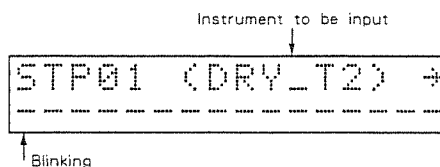

Press Pad Key **13** to choose the kick drum. “DRY_K1” will be displayed. Start play. The method of input is exactly the same as you have done so far. The kick should be heard on the first time signature of the 2nd measure, so press Pad Key **1** to specify Step Number 1.

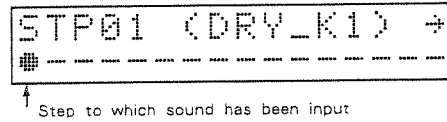

When you press the Pad Key, “●” will be displayed at the left edge of the display. This indicates that sound has been input for Step Number 1. The place blinking at the left side is Step Number 1, and at the far right is Step Number 16. So, in this manner, as sound is input, the corresponding Step indicator changes from “-” to “●”.

Input the crash cymbal in the same way.

Then, input the snare, with roll, from the 2nd to the 4th time signatures. With play stopped, press Pad Key **14** to select the snare, then start it again. The timing of the 2nd time signature falls on Step Number 5, so press all Pad Keys from **5** to **16**.

The display will show the following:

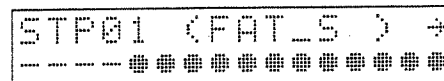

[Changing the pitch of sounds that have been input] See Owner's Manual, p. 58.

Next, using the Step Edit functions, try making changes in the roll for the snare you just entered.

Step Edit allows you to make changes in the parameters of sounds that have been input.

The parameters that can be changed are: Velocity (volume), Pitch, Decay (decay time), Nuance (timbre), and Pan (orientation).

Here, we will change the pitch.

Step Edit is performed from the Edit screen in Step Write.

Press **PAGE** to get the Edit screen.

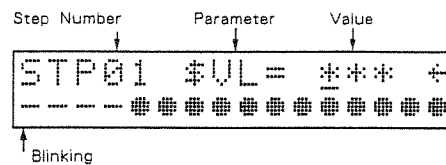

With play stopped, press the Pad Key for the snare.

Next, using **SELECT**, select "\$PT=". Then use **◀ ▶** to get the "●" at the very beginning of the roll to blink.

Press **START/STOP** to start play.

If you change the value using the **VALUE** slider, the pitch at the start of the roll will change. If you use **◀ ▶** to move the blinking location to another "●" at Step Numbers 6 - 16, the pitch of other Steps will change as well. Leave the setting at whatever you like.

When finished editing, press **PAGE** to return to the Basic screen.

Rhythm Pattern D

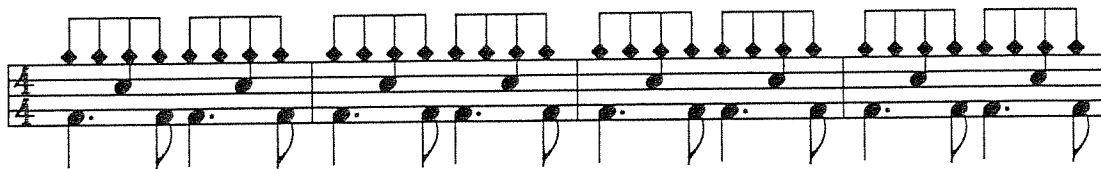

This rhythm pattern is very similar to pattern B, except that instead of the hi-hat, we have the ride cymbal. The kick and snare are exactly the same. So, here you can use the R-5's Pattern Copy and Instrument Change functions to make D based on B.

[Copying performance data] See Owner's Manual, p. 54.

With play stopped, select pattern number 91 (rhythm pattern B). Then, while holding down **SHIFT**, press pad number 9 (COPY).

A Pattern Copy screen like below will appear:

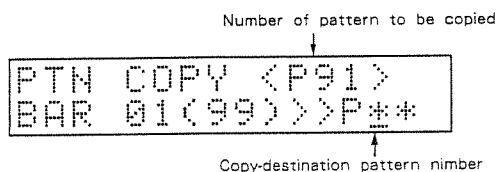

Use the Numerical Keys to enter 93, the number of the pattern that becomes the destination of the copy, and press **ENTER**. With this step, the performance data in pattern number 91 will have been copied to pattern number 93.

[Changing instruments] See Owner's Manual, p. 48.

Next, using the Instrument Change function, the hi-hat in pattern number 93 will be changed to a ride cymbal.

Select rhythm pattern 93 using **-1/OFF**, **+1/ON**.

Next, while holding down **SHIFT**, press Pad Key **1** (INST CHANGE).

```

INST CHANGE <P93>
DRY_K1 >> (***** )

```

↑ Instrument to be changed
↑ The new Instrument to be set

Using **-1/OFF**, **+1/ON** select “CLSD_H”. Then press Pad Key **4** to specify “RIDE_C”.

Press **ENTER**, and the hi-hat will be replaced by the ride cymbal.

Start play, and confirm that this has taken place.

【Changing the pan】

Next, as one more example of Step Editing, try editing the Pan for the ride cymbal.

Press **PAGE** twice to change to the Edit screen. Then, with **SELECT** choose “\$PN=”. With play stopped, press Pad Key **4** to select the ride cymbal.

```

Step Number      Pan      Value
↓               ↓       ↓
STP01  $PN=*OFF* ←
■-■-■-■-■-■-■-■-■-
↑ Blinking

```

Start play, use **◀▶** to get “●” blinking, and change the value with the VALUE slider. You can choose the orientation from among 7 settings, L3 - R3. By repeating the same procedure, you can set the Pan for each Step to whatever you like.

At this time if you continue pressing **▶** to proceed through the Step Numbers, after Step Number 16, the screen for specifying the Steps for the 2nd measure will appear.

Using the same operation, you can also change to the screens for the 3rd and 4th measures.

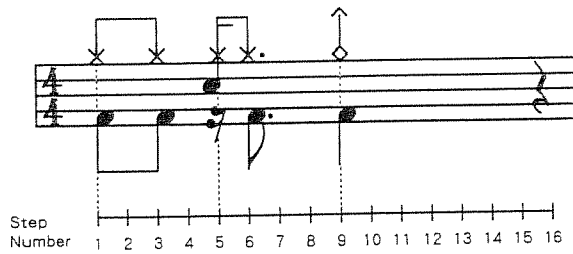

Rhythm Pattern E



* For explanation of the notation, see p. 12.

Now, finally, we will make the rhythm pattern that forms the ending, at pattern number 94. For reference, the notation shows a pattern E, but you might want to try a different arrangement.

Rhythm patterns can be created using similar procedures in any screen, whether it is the Basic, Write, or Edit screen.

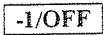
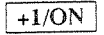
The rhythm patterns made so far, A to D, were created while Step length was set to a 1/16 note. But, should you wish to make a triplet-based rhythm pattern, you would need to change Step length to triplets. The length of a Step is set in the Basic screen, at the lower right, as the value for "D=". With play stopped, use   to move the cursor, and with ,  change to "TRI". In this case, 12 becomes the number of Steps in a measure.

3. Arranging rhythm patterns to create a song

Thus far, we have gone through creation of 5 rhythm patterns, at pattern numbers 90, 91, 92, 93, and 94. Next, these patterns will be arranged in the order they are to be played, to form a song.

Press **SONG** to enter the Song mode.

```

  █PLAY  █WRITE
  
```

* Should the Menu screen not appear, press **EXIT** .

Press **1** in the Numerical Keys to select "PLAY", and specify the song number. Here, we will make the song at song number 1.

Press **EXIT** to return to the Menu screen, then press **2** in the Numerical Keys to specify "WRITE". The Song Write screen will be displayed as follows:

```

      Song Number
      ↓
  SONG1 < WRITE >
  PART 001 P33-01?
      ↑           ↑
  Part Number  Pattern Number
  
```

Starting with pattern number 90, the patterns are arranged in order.

Whenever you wish to listen to the rhythm pattern while creating a song, press **START/STOP** .

After pressing 90 with the Numerical Keys, and pressing **ENTER** , pattern number 90 is written to the song.

```

  SONG1 < WRITE >
  PART 002 P90-01?
  
```

The Part number in the display advances to 2, showing it is ready for input of the next pattern. In this manner, each rhythm pattern written to a song is given a Part number, counting in order from the top of the song. Next, press **-1/OFF** , **+1/ON** and select pattern number 91. Press **ENTER** to write it as Part 2. Do the same for pattern numbers 92 - 94.

Once writing of the 5 rhythm patterns have been completed, stop play. Next press **EXIT** to return to the Menu screen, and use Numerical Key **1** to specify "PLAY".

When you then press **START/STOP** , the rhythm patterns will be played one after another in the order written into the song.

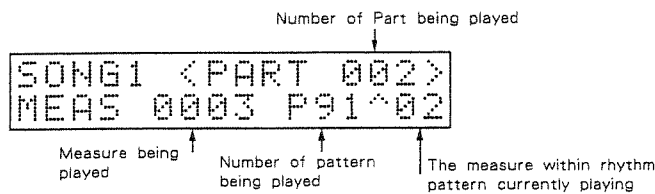

Once rhythm pattern E has played, it will stop automatically. You have thus been able to successfully have the R-5 play the song appearing in the score on page 12. To end with, we have an example of Song Editing, so you can try using repeat marks in the song.

[Setting repeat marks] See Owner's Manual, p. 70.

Through setting repeats in a song, you can have certain patterns play numerous times. Here, we will have pattern number 91 play twice. The repeat marks are set before and after the rhythm pattern as follows:

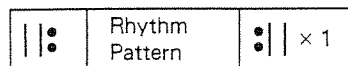

After pressing either **SONG** or **EXIT**, use Numeric Key **2** to specify "WRITE." Using **◀▶**, have the display show "PART 002 P91 - 04". Next, hold down **SHIFT** and press Pad Key **6** (PART INSERT).

```
PART INS <SONG1>
PART 002 P91-04?
```

This screen is used for adding data to a song after it is written.

Press **SELECT** to choose "|| :", and press **ENTER**.

With this step, the repeat symbol "|| :" has been written, in front of pattern number 91.



Here, use **◀▶** to change Part numbers, and take a look at the numbers of the Parts written in the song. You can see that the repeat mark is now at Part 2, and all other Part numbers after it have advanced by one. This shows how repeat marks are handled; they are treated the same as a rhythm pattern, as one Part. Within songs, all song data, such as rhythm patterns or repeat marks, are considered as one Part.

Next, at Part number 4, we place another repeat mark, a ": || × 01". Using **◀▶** have the display show "PART 004 P92 - 02".

While holding down **SHIFT**, press Pad Key **6** (PART INSERT) to get the Part Insert screen. Next, use **SELECT** to choose ": || × 01", then press **ENTER**.

The repeat marks have thus been inserted before and after rhythm pattern 91.

Choose "PLAY" from the Menu screen and listen to the song. This time you can hear rhythm pattern 91 played 2 times.

To conclude, you should once again check all the Parts you have written in the song. In the Song Write screen, use   to look through the Part numbers. The data for each Part should list as follows:

PART 001 P90 – 01
PART 002 || :
PART 003 P91 – 04
PART 004 :|| × 01
PART 005 P92 – 02
PART 006 P93 – 04
PART 007 P94 – 01

In progressing through the Part numbers, you have reached the end of the song when you reach a number which has “?” displayed to its right. Note that the Part number appearing alongside “?” is not included in the song. Also, though not explained here, tempo and level changes can be written into a song as well, using procedures similar to the above. You may want to test their effect, so refer to the Owner’s Manual.

R-5 HUMAN RHYTHM COMPOSER

Owner's Manual

Thank you for purchasing the Roland R-5 Rhythm Composer.

The R-5 is an innovative new rhythm machine featuring various functions that make it easy to program extremely realistic rhythm performance.

To make the best use of the R-5, please read this owner's manual carefully.

For the U.K.

IMPORTANT: THE WIRES IN THIS MAINS LEAD ARE COLOURED IN ACCORDANCE WITH THE FOLLOWING CODE.

BLUE	:	NEUTRAL
BROWN	:	LIVE

As the colours of the wires in the mains lead of this apparatus may not correspond with the coloured markings identifying the terminals in your plug proceed as follows:

The wire which is coloured BLUE must be connected to the terminal which is marked with the letter N or coloured BLACK.

The wire which is coloured BROWN must be connected to the terminal which is marked with the letter L or coloured RED.

Copyright © 1989 by ROLAND CORPORATION

All rights reserved. No part of this publication may be reproduced in any form without the written permission of ROLAND CORPORATION.

CONTENTS

Important Notes	7
About This Manual	8
Outline of the R-5	9
1. Human Feel	9
2. Features	10
Panel Descriptions	11

Before Creating Rhythms

1. The Process of Rhythm Creation	14
2. Operation	17
1. Arrangement of Modes	17
2. Basic Operations	19

Rhythm Patterns

1. Creating Rhythm Patterns	26
1. Real-time Write	27
a. Initial Settings	27
b. Setting Quantize	28
c. Inputting the Sounds	29
● Inputting Roll	31
● Inputting Flam	31
d. Erasing Sounds That Have Been Input	32
e. Setting the Metronome	33
f. Setting Roll	34
g. Setting Flam	34
2. Step Write	36
a. Concept of Step Writing	36
b. Initial Settings	38
c. Input of Sound	39
1) Fundamental Step Write	39
● Inputting Flam	41
2) Step Write in the Write Screen	42
● Scope Function	43
2. Playing Rhythm Patterns	46
1. Playing Programmable Patterns	46
2. Play of Preset Patterns	47

3. Editing Rhythm Patterns	48
1. Rhythm Pattern Editing	48
a. Instrument Change	48
b. Pattern Append	49
c. Pattern Extract	50
d. Pattern Merge	52
e. Reframe	53
f. Pattern Copy	54
g. Swing	56
2. Editing the Sequence Parameters	58
a. Real-time Edit	60
b. Step Edit	61

Songs

1. Creation of a Song	66
1. Basic Song Writing	67
2. Settings for Song Data and How They Work	70
a. Repeat	70
b. Tempo Change	71
c. Level Change	72
d. Label	73
● Setting a Label	73
● Search Label	74
2. Playing a Song	75
1. Song Play	75
a. Continue Play	76
b. Start and Stopping Using a Pedal Switch	76
2. Song Chain	77
3. Search Label	78
4. Initial Tempo and Initial Level	79
3. Song Editing	80
1. Part Delete	80
2. Part Insert	81
3. Part Copy	82
4. Song Copy	83
5. Song Name	84
6. Song Clear	85

Settings for Instruments

1. *Instrument Assignment* 88
 - Multi Assign 90
2. *Editing Sounds* 91
 1. Parameters Affecting the Sound 91
 2. Sound Parameters 94
 - a. How the Parameters Work 94
 - b. Editing 98
 3. Copy Instruments 100
 4. Performance Parameters 102
 - a. How the Parameters Work 102
 - b. Editing 103
 - c. Align 104
3. *Adjusting Instrument Level* 106

Feel Patches

1. *Feel Patches* 108
2. *How the Parameters Work* 110
 1. Patch Parameters 110
 - a. Groove Select 110
 - b. Instrument Select 111
 2. Feel Parameters 111
 - a. Groove Switch/ Random Factor Switch 111
 - b. Groove 111
 - c. Random Factor 111
 - d. Instrument Switches 112
3. *Setting Parameters* 113
 1. Setting Patches 113
 2. Setting Groove 114
 3. Setting Random Factor 116
 4. Assigning Feel Patches 118
 5. Copying Feel Patches 119

Other Functions

1. *Condition Function* 122

2. *Utilities* 123
 1. All Song Clear 123
 2. All Pattern Clear 124
 3. Available Memory 124
3. *Initialization and Clearing* 125
 1. Initializing the Sound Parameters 125
 2. Clearing the Performance Parameters 126
 3. Initialization of Instrument Assignment 127
 4. Clearing Feel Patches 128
 5. Initializing the Feel Patches 128
 6. Initialization of Note Numbers 129
 7. Initialization of the R-5 129
4. *Tape Interface* 130
 1. Saving 130
 2. Verify 132
 3. Load 133
5. *Synchronized Play* 134
 1. Settings for the Sync Mode 134
 2. MIDI Sync 135
 3. Tape Sync 136

MIDI

1. *Concerning MIDI* 140
2. *Settings for the Instrument Section* 141
 1. Receive Channel 141
 2. Transmit Channel 142
 3. Note Numbers 143
 4. Control Change 144
3. *Settings for the Performance Section* 146
4. *Function Switches* 148
5. *Data Transfer Using Exclusive* 151
 1. Transmission (Bulk Dump) 151
 - Transfer of Sound Parameters 152
 2. Reception 153

Getting the Most out of The R-5

1. *Connection with an external MIDI device* 156
 - The R-5 becomes a MIDI sound module .. 156
 - Using an external MIDI sound module to accompany play on the R-5 157
 - Using a sequencer to organize the R-5's performance data 158
2. *Creation of Rhythm Patterns* 162
 - Using open hi-hat for input of hi-hat 162
 - Using Roll during input of hi-hat 162
 - Inputting accents 162
 - Making a new rhythm pattern using the editing functions 162
 - Playing chords with one instrument 164
3. *Creation of Songs* 165
 - Fade-in and Fade-out 165
4. *Adding Effects* 166
 - Using REST for mutes 166
 - Getting a stereo reverb for the snare 167
 - Effects with the crash cymbal 167
5. *Feel Patches* 168
 - Changing at random the hitting position for the ride cymbal 168
 - Creating a Feel Patch for a 16 beat hi-hat 168

Reference

1. *Error Messages* 170
2. *Troubleshooting* 173
3. *Blank Chart* 179
4. *Instrument List* 185
5. *Preset Patterns* 188
6. *Pad Banks : Default Settings* 189
7. *Sound Parameters : Default Settings* 191
8. *Note Numbers : Default Settings* 194

- Roland Exclusive Messages* 195
MIDI Implementation 199
MIDI Implementation Chart 206

- Specifications* 208
Index to Terms Used 210

IMPORTANT NOTES

When employing an AC adaptor, make certain you use only one that has been supplied by the manufacturer. Use of any other power adaptor could result in malfunction or damage.

Concerning the power supply

- Whenever you make any connections with other devices, always turn off the power to all equipment first. This will help in preventing malfunction, and damage to speakers.
- Do not force the unit to share the same power outlet as one used for distortion producing devices (such as motors, variable lighting devices). Be sure to use a separate power outlet.
- Before using the AC adaptor, always make certain the voltage of the available power supply conforms to its rating.
- Do not place heavy objects onto, Step on, or otherwise risk causing damage to the power cord.
- Whenever you disconnect the AC adaptor from the outlet, always grasp it by the plug, to prevent internal damage to the cord and the hazard of possible short circuits.
- If the unit is not to be used for a long period of time, unplug the cord from the socket.

Concerning placement

- Avoid using or storing the unit in the following places, as damage could result.
 - Places subject to extremes in temperature. (Such as under direct sunlight, near heating units, above equipment generating heat, etc.)
 - Places near water and moisture. (Baths, washrooms, wet floors, etc.) Places otherwise subject to high humidity.
 - Dusty environments.
 - Places where high levels of vibration are produced.
- Should the unit be operated nearby television or radio receivers, TV pictures may show signs of interference, and static might be heard on radios. In such cases, move the unit out of proximity with such devices.

Maintenance

- For everyday cleaning, wipe the unit with a soft dry cloth, or one that is dampened slightly. To remove dirt that is more stubborn, wipe using a mild, neutral detergent. Afterwards, make sure to wipe thoroughly with a soft cloth.
- Never apply benzene, thinners, alcohol or any like agents, to avoid the risk of discoloration and deformation.

Other Precautions

- Do not hit Pad Keys with a hard stuff such as a stick.
- Protect the unit from strong impact.
- Avoid getting any foreign objects (coins, wire, etc.), or liquids (water, drinks, etc.) into the unit.
- Never apply strong pressure to the display, or strike it in any way.
- At any time that you notice a malfunction, or otherwise suspect there is damage, immediately refrain from using the unit. Then contact the store where bought, or the nearest / Roland Service Station.

Concerning memory backup

- Within the unit is contained a battery which serves in maintaining the contents of memory while the main power is off. The normal life of this battery is 5 years or more, but it is strongly recommended that you change it every 5 years as a rule. When it is time to change the battery, contact a Roland Service Station.
 - * The first time you need to change the battery could occur before 5 years have passed.
- Please be aware that the contents of memory may at times be lost; when sent for repairs or when by some chance a malfunction has occurred. Important data should be saved on tape, or written down on paper. During repairs, due care is taken to avoid the loss of data, however, in certain cases, such as when circuitry related to memory itself is out of order, we regret that it may be impossible to restore the data.

About This Manual

This manual explains the use of each function available with the R-5. During the process of actual creation of rhythms for the R-5, you will need to work with a combination of many of these functions.

For those using a rhythm machine for the first time, start by reading the separate "Guidebook". After gaining a basic grasp of the operational methods, you will then be ready to make better use of this manual.

Additionally, refer to the chapter, "Getting the most out of the R-5", which offers explanation of actual applications combining a range of functions, which are expanded on while dealing with several examples.

* The explanation of certain procedures may be abbreviated in places, so before attempting to operate the unit, first read "Basic Operations", page 19.

● In this manual, buttons are indicated with the name appearing above the actual buttons.

For example: SONG means Song Button.

Outline of the R-5

1. Human Feel

Most persons, upon hearing rhythm performances generated by conventional rhythm machines or sequencers, are left with the impression that they are “monotonous and mechanical”.

The R-5 rhythm machine was developed specifically to alleviate this problem, and make possible a dimension of expression more closely matching that of a real drummer.

Reasons behind monotonous and mechanical rhythms

There are two factors, as follows, that are evident when considering why a performance sounds uninspiring and lacking in naturalness.

- A drummer, in order to emphasize certain beats or provide accent, will consciously vary the strength of certain hits or their position. It is for this reason that even with identical content being played, the excitement of a performance will be different depending on the particular drummer.
- During a drummer’s performance, the timing, strength, or position of the hits may vary unintentionally. For this reason subtle changes in timbre can occur, which take away from an impression of monotony.

In an actual performance these factors combine to produce a human, natural performance.

R-5 Functions

The R-5 has taken into account the above factors, and is equipped with the following features that make possible a more human-sounding performance. (Human Feel)

- **Natural changes in timbre depending on the strength or position of hits.**
With instruments such as snare, kick and tom you can obtain natural variations in the sound depending on how hard you hit the Pad Keys. With the hi-hat or ride cymbal, through changes in a parameter (Nuance), you can also achieve changes in tonal expression relevant to changes in the hitting position. By having control over timbre similar to acoustic instruments through such setting changes, you are able to create more natural, human rhythms.
- **Wealth of timbre editing parameters**
Each instrument (rhythm sound) can be modified to suit a particular performance or song through settings for the parameters of Pitch, Decay, Nuance, and Pan. These parameters can be set relative to each and every note in a rhythm pattern.

● **Feel function**

Information on how timbre is to change can be stored as a “Feel Patch”, separate from the rhythm pattern itself.

Included in Feel Patches are the “Groove”, which are parameters for getting cyclical changes in the hitting strength and position; and the “Random Factor” which is a parameter that randomly applies subtle changes to the timbre.

Simply by assigning a Feel Patch to a rhythm pattern the performance is accentuated in a more human way. Even when using the same rhythm pattern, you can obtain noticeable differences in the level of excitement as a result of different settings for the Feel Patch.

2. Features

- Contains 68 different instruments (rhythm sounds); all high quality sounds sampled at 44.1 kHz, with a 16 bit dynamic range. Moreover, since each Pad Key is equipped with touch sensitivity, you can obtain expression of natural changes in volume or timbre depending on hitting strength.
- For the basic instruments, settings can be made for Nuance, which determines the hitting strength (drum family), or striking position (only with cymbal family); in addition to the settings made for Pitch/Decay/Pan. Nuance settings thus allow you to be more creatively precise with your sounds.
- A Copy Instrument function allows you to register up to 26 instruments for which timbre has been altered, over and above the 68 instruments available.
- The unit is capable of storing up to 100 different Programmable Patterns, and 6 songs in addition to the 32 Preset Patterns.
- Up to 8 Feel Patches can be stored to provide periodic changes in Velocity, Pitch, Decay, and Nuance; and can include settings for random change. Through application of Feel Patches to rhythm patterns, performances will sound much more realistic.
- A full range of functions for editing rhythm patterns have been provided. For example:
 - Using Extract, you can extract and move data for only a particular specified instrument.
 - Instrument Change allows you to replace any specified instrument already programmed within a rhythm pattern with another instrument.
 - The Merge function allows you to mix two rhythm patterns.
 - And, with Pattern Append, one rhythm pattern can be linked to another.

Panel Descriptions

Rear Panel

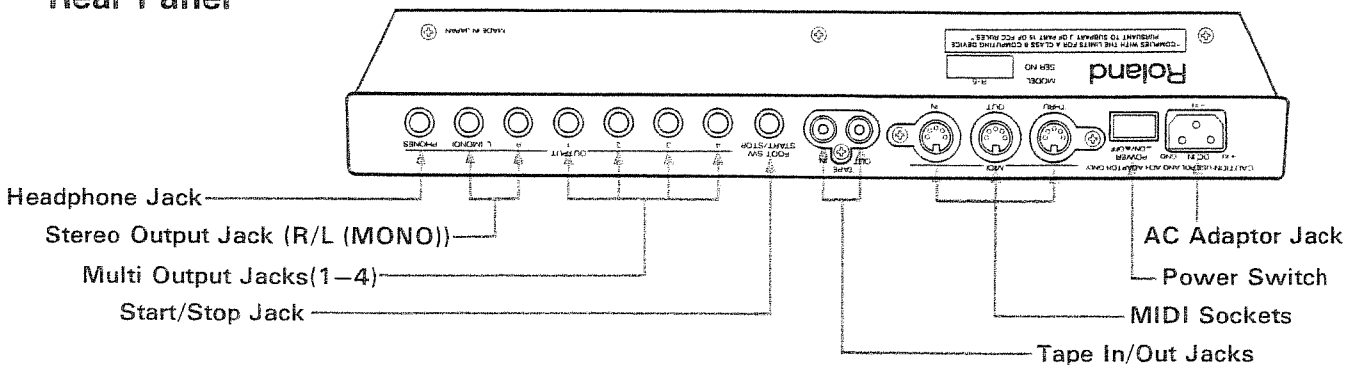

Front Panel

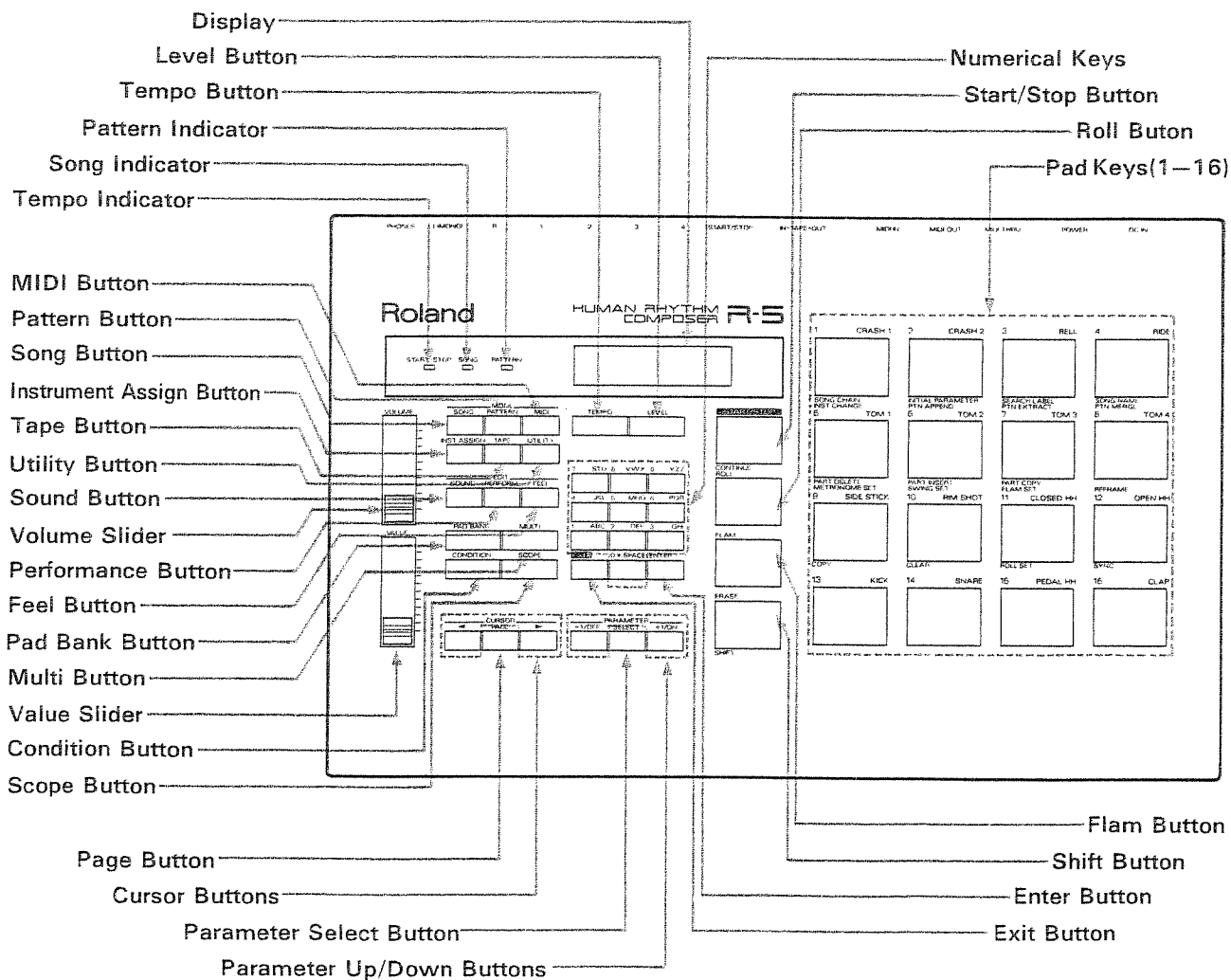

Before Creating Rhythms

1

The Process of Rhythm Creation

P.14

2

Operation

P.17

1. The Process of Rhythm Creation

On the R-5, the rhythm part for one song are composed of numerous individually created rhythm patterns.

So, first each pattern is made (Pattern Write), then the various patterns are combined in the order to be played to form a song (Song Write).

With either Pattern or Song Write, there are a wealth of editing functions available, greatly enhancing the efficiency of the process.

The procedure taken in creating a rhythm is as follows:

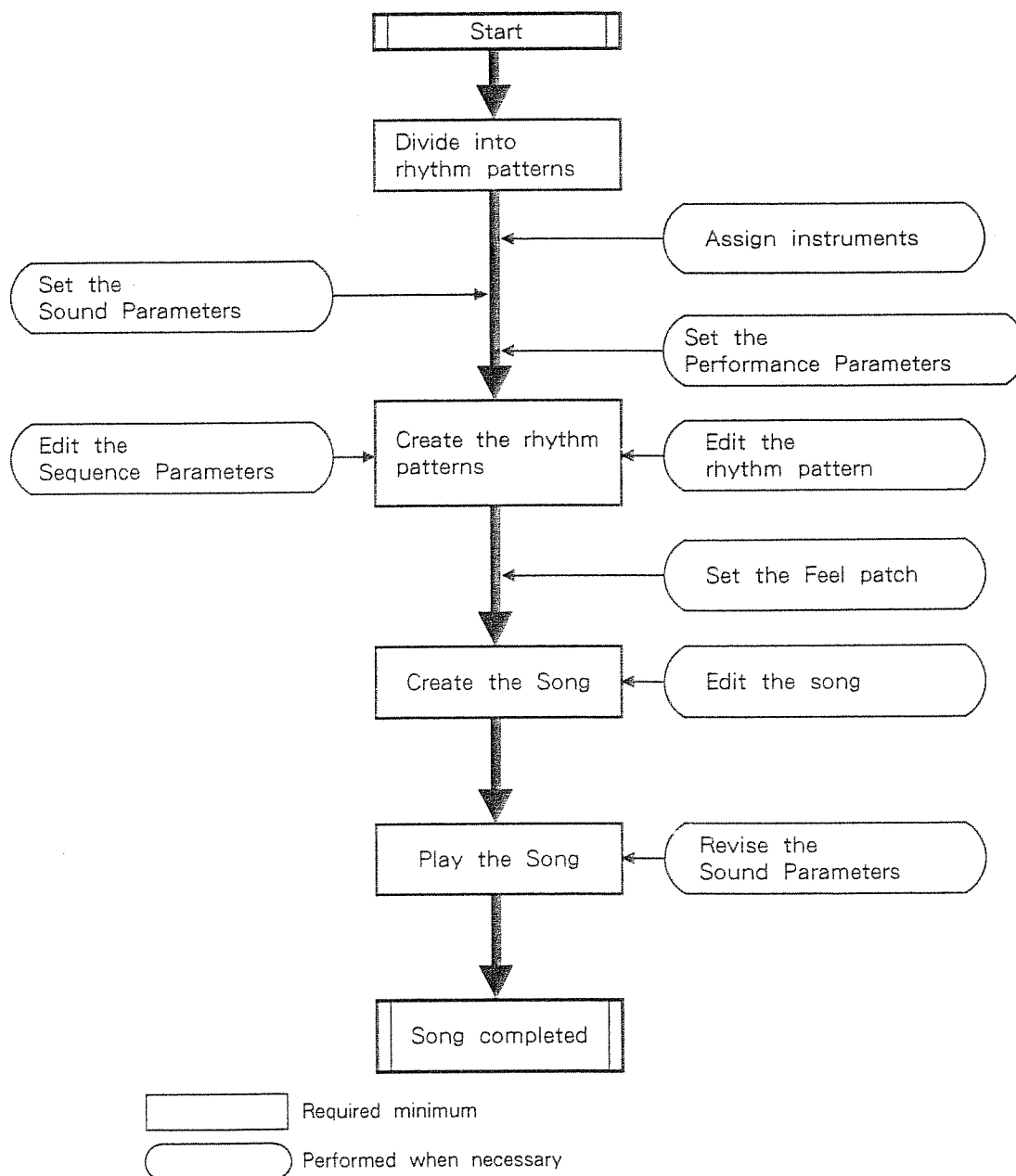

Divide into Rhythm Patterns

You need to divide the rhythm parts for the song into a number of rhythm patterns, corresponding to the structure of the song. Ordinarily, one rhythm pattern would consist of 1 to 2 measures, but when several measures make up a particular phrase, they can be included in 1 rhythm pattern.

Assign Instruments (☞ P.88)

The instruments to be used in the rhythm patterns should be assigned to the Pad Keys. At the factory settings, some instruments are not yet assigned to any Pad Keys. When you wish to use such instruments, you will need to use Instrument Assign to assign them to a Pad Key. In addition, depending on the patterns being worked on, you may wish to rearrange the instruments in a certain way within each Pad Bank.

Set the Sound Parameters (☞ P.94)

Before inputting the sounds for a rhythm pattern, you can determine the timbre for the instruments, a basic factor affecting the rhythm to be created.

Create the Rhythm Pattern (☞ P.26)

The rhythm pattern can be created either by tapping the Pad Keys in time to the metronome (Real-time Write), or by specifying, one note at a time, the timing at which each instrument will sound (Step-Write).

Set the Performance Parameters (☞ P.102)

When you wish to input different timbres for the same instrument depending on the rhythm pattern, the Performance Parameters should be edited before carrying out Pattern Write.

Edit the Rhythm Pattern (☞ P.48)

Using the various editing functions, you can take a basic rhythm pattern and create numerous variations on it. This is quite convenient when wanting to program numerous patterns similar in nature.

Edit the Sequence Parameters(☞ P.58)

Editing of timbre can be carried out on an individual note basis for the content of an existing rhythm pattern. By making changes in the settings for timbre on a per note basis, you are able to create a more realistic, human-like performance.

Set the Feel Patch (P.108)

By assigning a Feel Patch to a pattern, you can obtain performances having more human-like expressive energy. When you wish to apply the same expressive features to numerous rhythm patterns, it is more effective to use a Feel Patch, rather than edit the Sequence Parameters.

Create the Song
(☞ P.66)

All rhythms making up the song are combined by lining up the rhythm patterns in the order in which they are to be played.

Edit the Song
(☞ P.80)

A full range of editing functions, such as copy/deletion of portions of the song data, can be used to proceed efficiently with finalizing the song.

Play the Song
(☞ P.75)

Once created, the song is ready to be played. When you are not satisfied with the results, you can go back to the Song Write stage and make any necessary changes.

Revise the Sound Parameters

The Sound Parameters can be edited when, after a song has been completed, you wish to change the timbre of a particular instrument on a global basis (wherever it's used in all rhythm patterns)

2. Operation

1. Arrangement of Modes

The R-5 is equipped with a full range of functions; for editing the timbre of instruments (rhythm sounds), and for creating and editing rhythm patterns or songs. These functions are arranged into 6 Main modes (normal condition) and 3 Edit modes.

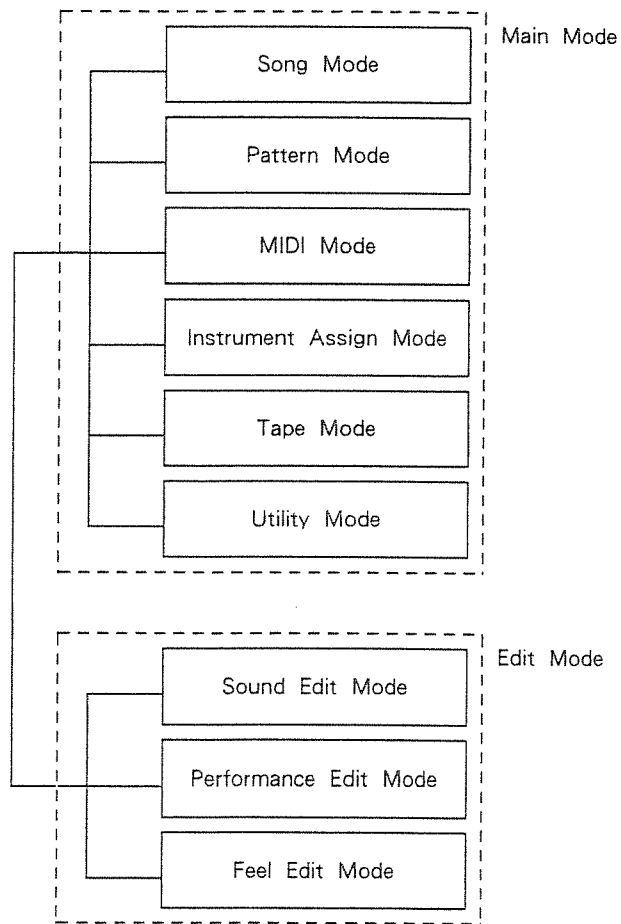

One of the Main modes is always selected whenever the R-5 is in operation. The Edit modes are temporary, and are called when necessary from a Main mode.

[Main Modes]

● **Song Mode**

Provides for song play/creation/editing.

● **Pattern Mode**

Provides for pattern play/creation/editing.

● **MIDI Mode**

Accepts settings for parameters relative to MIDI when using an external MIDI sound module, or when using the R-5 as a MIDI sound module.

● **Instrument Assign Mode**

Accepts settings determining which instruments are assigned to each Pad Key.

● **Tape Mode**

Allows for transferring the data created on the R-5 to audio recording tape.

● **Utility Mode**

Provides for erasure of all song or rhythm pattern performance data, and for checking the amount of free memory remaining for storing performance data.

[Edit Modes]

● **Sound Edit Mode**

Accepts settings affecting how each instrument will sound. The parameters set here are: Pitch, Decay, Nuance, Output Assign, Assign Type, and Sensitivity Curve.

● **Performance Edit Mode**

Accepts settings determining how instruments will sound, on an individual Pad Key basis. The parameters set here are: Pitch, Decay, Nuance and Pan.

● **Feel Edit Mode**

Accepts settings for Feel Patches.

2. Basic Operations

In many cases, when making settings for the R-5, the basic operations explained in the following may be sufficient to allow you to proceed. Otherwise, for each particular function the operational procedures are indicated, as necessary. However it should help even further if you read and get a good understanding of the general methods of operation that follow.

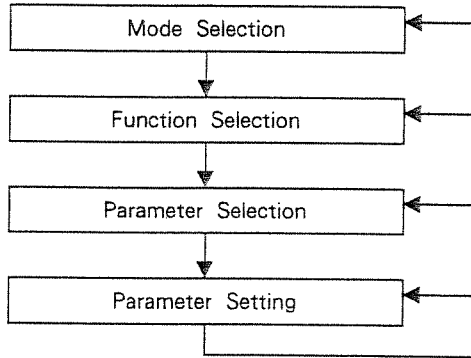

① Mode Selection

Press the button corresponding to the mode which provides the function you wish to use.

● Main Modes

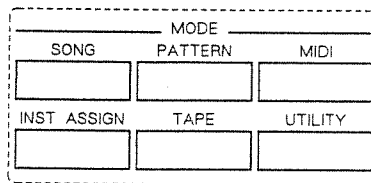

 (To select the Main Modes, play must be stopped)

● Edit Modes

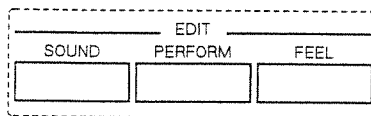

* To return to the original screen from the Edit Mode's screen, either press the same button again, or press the button for the Main mode you want.

Once a mode has been selected, a Menu screen such as shown below will appear.

(The Pattern Mode's Menu Screen)

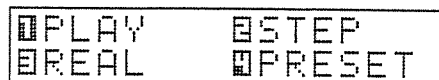

* Should the Menu screen not appear, press **EXIT**. When in a Main mode, a second press of the same button will give you the Menu screen.

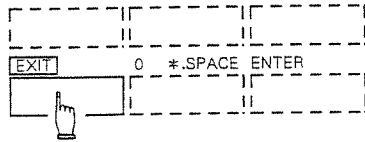

② Selection of Functions

With a mode selected, you can then select the function desired.

● The Menu screen displays the names of the functions which can be selected from that particular mode.

With modes having numerous functions, the Menu consists of more than one page, which is indicated by a “→” which appears at the right corner of the screen. At such times, press **PAGE** to change the screen.

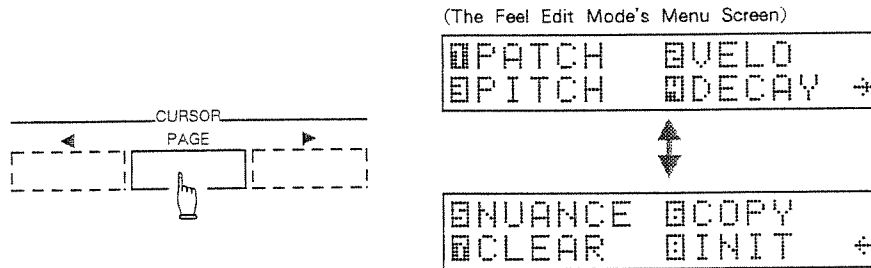

● Find the number to the left of the desired function, then enter it using the Numerical Keys to switch to the screen accepting settings for that function.

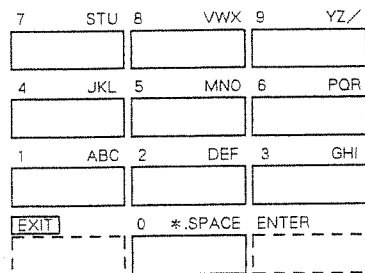

* Within modes having more than one Menu page, you can specify the number of a function even when the page it is on is not currently displayed.

Once a function has been specified, you are given the screen accepting settings for it.

(Sound Edit Screen)

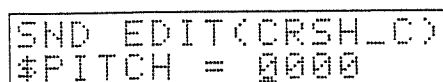

● For selection of other functions, first press **EXIT** to return to the Menu screen, then select the function.

● With the Song and Pattern modes, there are certain functions (the Shift Functions) that are not displayed in the Menu screen. To select Shift Functions, play must be stopped. Then **SHIFT** is held down while pressing the relevant Pad Key.

The names of all available Shift Functions are printed below the Pad Keys.

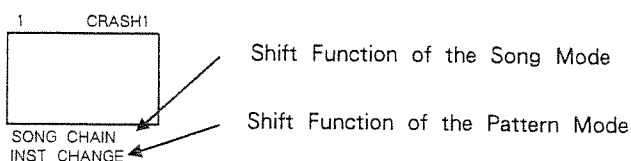

* Press **EXIT** to return to the previous screen.

③ **Selection of Parameters** Any particular function consists of a number of parameters. The parameter for which you wish to change settings can be selected by the buttons as shown below:

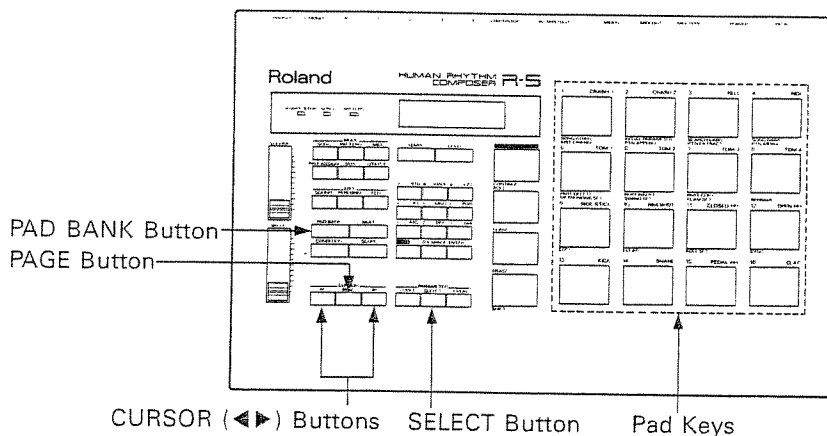

PAGE

With functions having numerous parameters, the screens span more than one page, which is indicated by a “→” which appears at the right corner of the screen. At such times, press **PAGE** to change to the screen containing the needed parameters.

◀▶ (Cursor Buttons)

Within screens where a number of parameters are displayed, you need to move the cursor (the lower bar, “_”) until it appears below the value for the parameter you wish to change.

SELECT

When there is a "\$" appearing to the left of the parameter, each press of **SELECT** provides change of the parameter.

PAD BANK / Pad Key

Used to select specific instruments, or for creating rhythm patterns.

- * In screens in which you can use the Pad Keys to select instruments, hold down **SHIFT** and press **+1/ON** (or **-1/OFF**) to select the next higher (or lower) numbered instrument. To hear the instrument selected, hold down **SHIFT** and press **SELECT**. Using this procedure, you can also select instruments not assigned to any Pad Keys.

④ Setting Parameters

The values for parameters can be changed using the buttons and sliders as shown below.

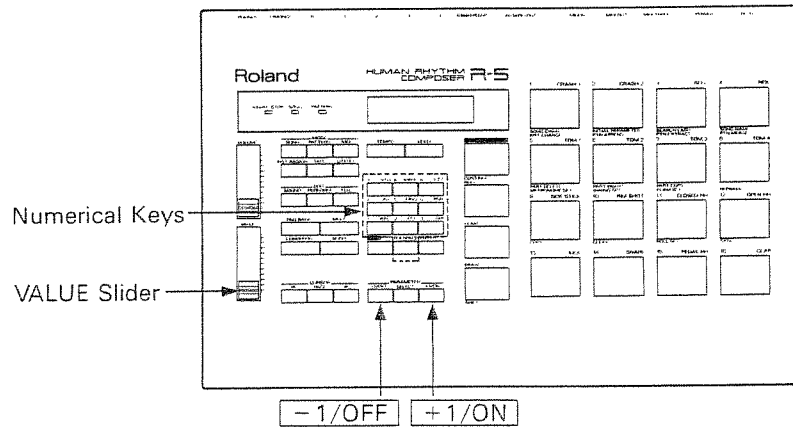
**-1/OFF, +1/ON**

Used when making precise changes in values.

Press **+1/ON** to increase the value, and **-1/OFF** to decrease it.

If you hold down **+1/ON** (or **-1/OFF**) while pressing **-1/OFF** (or **+1/ON**) you can obtain a more rapid increment(or decrement) of the value set.

VALUE Slider

Used to make broad changes in the value.

Numerical Keys

Used to enter directly a numerical value.

Whenever changing a 2 or 3 digit value to one with only 1 or 2 digits, you need to enter "0" before the number.

<Examples>

To change "123" to "15" enter "015" with the Numerical Keys.

To change "15" to "3" enter "03" with the Numerical Keys.

* The value of parameters inclosed with “*” (ex. “* POLY *”) cannot be changed using the Numerical Keys.

For settings such as for time signature or quantization, the value can be set using Numerical Keys [1]-[9], as below.

7	STU	8	VWX	9	YZ/
	1/32		1/48		HIGH (1/96)
4	JKL	5	MNO	6	PQR
	1/12		1/16		1/24
1	ABC	2	DEF	3	GHI
	1/4		1/6		1/8

The characters printed above the keys can also be used for entering the names for songs or Labels.

The meaning of the symbols displayed during operation are as follows:

Mode	Display	Description
Function Selecting Parameter Selecting	↔ ↔ Lower right corner or upper right corner	The screen can be changed with [PAGE]. → shift to the next screen. ← shift to the first screen.
Parameter Selecting	⌘ Parameter Name	Pressing [SELECT] changes the parameters.
Parameter Setting	* Value *	The value cannot be entered with Numerical Keys.
	* * *	The value is not set or cannot be set.
Instrument Selecting	{ Instrument Name }	Specify the instrument with a Pad Keys. * If you hold down [SHIFT] while pressing [+1/ON] (or [-1/OFF]), you can select the next higher (or lower) numbered instrument. Hold down [SHIFT] while pressing [SELECT] to listen to the selected instrument.
Rhythm Pattern Display	P 00 - 00	Pattern number and the number of measures contained.
	P 00 ^ 00	Pattern number and current measure.
	P 00 ... 00	Pattern number and the measure number that can be written(in the Step Writing).
	P 00 - 00 #	Data is written in the pattern number currently shown.
	P 00 - 00 *	No data exists in the pattern number currently shown.
Song Writing	?	No data is written in the selected Part. Or the data currenty shown in the display is not yet written in the Part.

Rhythm Patterns

1	<i>Creating Rhythm Patterns</i>	<i>P.26</i>
2	<i>Playing Rhythm Patterns</i>	<i>P.46</i>
3	<i>Editing Rhythm Patterns</i>	<i>P.48</i>

1. Creating Rhythm Patterns

As programmable patterns, up to 100 original rhythm patterns (maximum of 99 measures per pattern) can be created.

* There are of course limitations on the amount of performance data that can be stored. For this reason, if you make rhythm patterns that have many numbers of notes or measures, 100 types may not be available for creation. (For programmable patterns 00 through 99, a total of 2,600 notes can be input.) When you wish to check how much room you have left for creating rhythm patterns, use the Available Memory procedure (page 124).

For Pattern Write, the following two methods are available:

● Real-time Write

The performance information you create by tapping the Pad Keys, in time with the metronome, is stored directly to the programmable pattern. You can correct the timing mistakes you might make using the *Quantize function* (page 28).

● Step Write

You specify one at a time the timing of each note to be sounded (Step), for each instrument. This allows persons not skilled in correctly tapping the Pad Keys to create well-timed rhythm patterns.

You can also switch between Real-time and Step Writing as needed during creation of a rhythm pattern. Step Writing can be used to set a basic pattern, and extra sounds can then be added using Real-time Writing. Or, a pattern can be first captured in Real-time and then portions can be edited using Step Write.

1. Real-time Write

a. Initial Settings

Select the number of the pattern (00 - 99) for which a rhythm pattern is to be input, and set the time signature and number of measures.

[Step 1] Press **PATTERN** to enter the Pattern mode.

```

PLAY    STEP
REAL    PRESET
  
```

* If the Menu screen does not appear, press **EXIT**.

[Step 2] Press Numerical Key **3** to specify "REAL".

Pattern Number (00 to 99)
 ↓
 ↓ Number of measures in rhythm pattern
 P00-01* < REAL >
 T=04/ 4 Q=1/16 →
 ↑ Time Signature ↑ Quantize

[Step 3] Use **-1/OFF**, **+1/ON** to select a pattern number (00 to 99).

If there is data in the selected rhythm pattern, the display will appear as shown below:

Indicates there is performance data in rhythm pattern
 ↓
 P01-01↓ < REAL >
 T=04/ 4 Q=1/16 →

When you wish to edit the selected rhythm pattern, you can continue on to "b. Setting Quantize".
 (No changes can be made in the time signature or number of measures for rhythm pattern for which performance information has already been input.)

[Step 4] While holding down **SHIFT**, press Pad Key **10**.

(When there is performance data)

```

PTN CLEAR <P00>
INST=ALL
  
```

(When there is no performance data)

```

PTN FORMAT <P00>
T= 04/ 4 BAR= 01
  
```

When a rhythm pattern containing performance data has been selected, press **ENTER** and all data will be erased.

* To abort the procedure, press **EXIT**.

[Step 5] Set the number of measures (1 - 99) the rhythm pattern will have using **-1/OFF**, **+1/ON**.

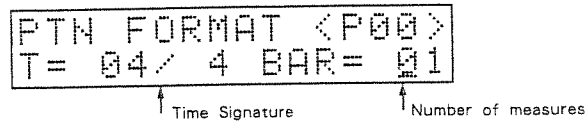

[Step 6] Set the time signature for the rhythm pattern. Position the cursor using **◀ ▶** to the number to be set, and set with **+1/ON**, **-1/OFF**.

(Available settings: 1/4 - 8/4, 1/6 - 12/6, 1/8 - 16/8, 1/12 - 24/12, 1/16 - 32/16, 1/24 - 48/24, 1/32 - 64/32)

[Step 7] Press **ENTER** to return to the Real-time Write screen.



Next, go on to make the setting for Quantize.

b. Setting Quantize

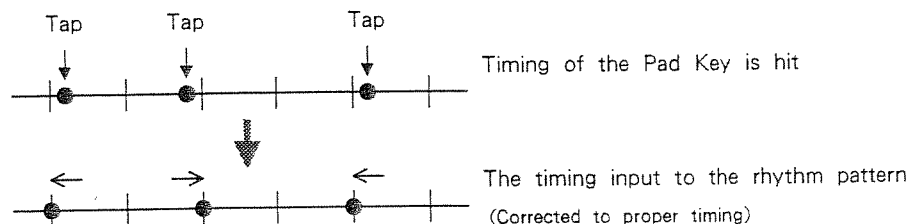

Quantize corrects the timing inaccuracies that may have occurred when you played the Pad Keys. For example, with Quantize set to 1/16, input will take place correctly, as sixteenth notes, even should you be somewhat off with the timing when you tap the Pad Keys. Ordinarily, it is set at the value of the smallest note being entered, but if you want notes to be entered at the same timing as the Pad Key are tapped, set it to "HIGH".



When you want to change Quantize, carry out the following procedure from the Real-time Write screen.

[Step 1] Using   position the cursor at the value set at "Q=."

```
P00-01* < REAL >
T=04/ 4 Q=1/16 +
          ↑
    Setting for Quantize
```

[Step 2] Set the Quantize value using , .

(Available settings: 1/4, 1/6, 1/8, 1/12, 1/16, 1/24, 1/32, 1/48, HIGH (1/96))

* The Quantize value can be changed even during play with Real-time Write. In such cases, input at the newly set Quantize will start from the measure coming after the one it was set in.

c. Inputting the Sounds

* With Real-time Write, the metronome is used to provide the timing for the performance. The factory settings call for a count in quarter note to be sounded. To change this setting, refer to page 33.

* In inputting a rhythm pattern the instruments assigned to the Pad Keys will be used. Should you wish to use instruments that are currently not assigned to any Pad Bank, assign the desired instruments to Pad Keys using Instrument Assign (p. 88).







Now you are ready for input using Real-time Write.

[Step 1] Press  to start play.

```
Measure currently being input   Real-time Write in progress
          ↓                       ↓
P00^01* <+REC!!>
T=04/ 4 Q=1/16 +
```



The count will be heard; in keeping with the setting for the metronome .

When you are going to start input from a measure lying partway through a rhythm pattern having multiple measures, [Step 1] should be carried out as follows instead:

- ① Using  , move the cursor to the measure number position, and specify the measure using , .
- ② While holding  press .

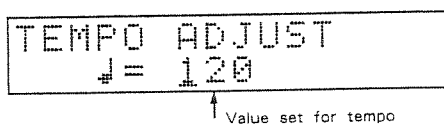
[Step 2] Press .



[Step 3] Adjust the tempo (40 - 250) using , .

The higher the value, the faster the tempo will be.

* The VALUE slider cannot be used to change tempo.

* While in the tempo setting screen, anything played with the Pad Keys will not be entered into the pattern, so you can also use it for practice before starting.

[Step 4] Once the tempo has been set, press  once again to return to the Real-time Write screen.

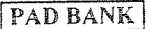
[Step 5] Input the instrument sounds by tapping the Pad Keys in time with the metronome. Use  to change Pad Banks when necessary.

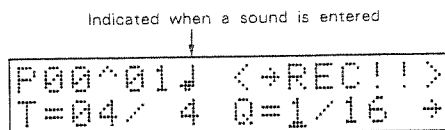

Once the sounds have been input, they are repeatedly played for the set number of measures. During play you can tap the Pad Keys to add more sounds.

[Step 6] Press  to stop play.

[Step 7] Press  to return to the Menu screen.

● Inputting Rolls

Roll is a technique where a sound is produced repeatedly at the same intervals.

For employing Rolls, perform the following procedure with play started, in Real-time Write.

[How] While holding down **ROLL**, continue pressing a Pad Key.

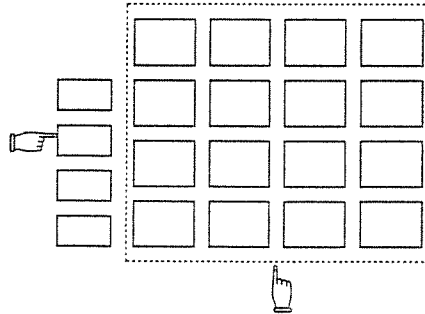

The roll effect is input for as long as the Pad Key is pressed. The volume can be changed by altering the pressure that you apply to the Pad Key at this time.

- * Quantize should be set to intervals equivalent to that of the roll, or finer. When quantize is not set finer than the intervals of the Roll effect, you may not be able to obtain input as desired.
- * To change the Roll Interval, carry out the procedure on page 34.
- * The roll effect can be used in modes other than Pattern Write as well. Even with play stopped, the speed of the roll changes in response to changes in tempo settings.

● Inputting Flam

Flam is a performance technique whereby the two sticks are made to hit the snare or other drum at almost the same instant, except that one is slightly different in terms of timing and velocity.

To input the flam effect, perform the procedure as follows while in Real-time Write, and with play started.

[How] Hold down **FLAM** while pressing the desired Pad Key.

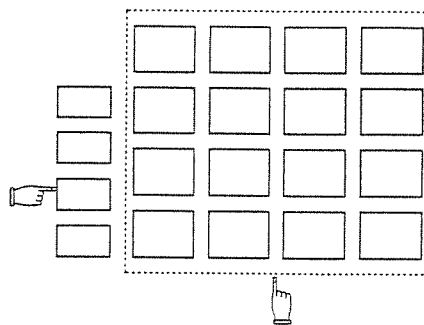

- * To change the settings for Flam, carry out the procedure on page 34.

d. Erasing Sounds That Have Been Input

Sounds that have been input into a rhythm pattern can be erased, on a per instrument basis, using the procedures that follow. Whenever you have mistakenly input sounds, they can be erased, allowing you to do them over again.

● **To erase during play** Do the following while in Real-time Write, and with play started.

[How] While holding down **SHIFT**, continuously press the Pad Key corresponding to the instrument you wish to erase.

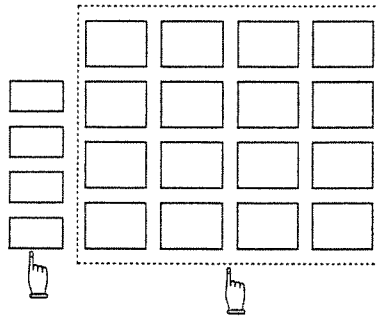

You thus accomplish erasure of portions of sound, corresponding to where you pressed the Pad Key.

● **To carry out complete erasure** With play stopped in any Pattern mode (either “PLAY”, “REAL”, or “Step”), carry out the following:

[Step 1] While holding down **SHIFT**, press Pad Key 10.

```
PTN CLEAR <P00>
INST=ALL
```

[Step 2] Using **-1/OFF**, **+1/ON**, select the instrument you wish to erase.
All instruments contained in the rhythm pattern will be displayed in revolving order.

```
PTN CLEAR <P00>
INST=DRY_K1
```

↑
Instrument to be erased

* Press **SELECT** to listen to the selected instrument.

[Step 3] Press **ENTER**.

This erases the sounds only for the specified instrument.

e. Setting the Metronome

The parameters determining how the metronome will be sounded during Real-time Write are set as follows:

● Interval

Select the interval at which the count will be sounded from the following:
1/4, 1/6, 1/8, 1/12, 1/16, 1/24, 1/32.

● Mode

The different ways of using the metronome are selected from the following three modes:

- REC ON:** The metronome always sounds (during Real-time Write).
- EMPTY:** The metronome sounds only when there is no data in the rhythm pattern; it stops once data has been input.
- OFF:** The metronome does not sound.

● Level

The level of the metronome can be set from 0 to 15. At 0 the metronome does not sound.

● Output

The jack from which the metronome will be output can be selected (Stereo Output, Multi Outputs 1 - 4). With stereo output you can also select from 7 possible orientations. (LEFT 1 - 3, CENTER, RIGHT 1 - 3)

With play stopped in the Pattern mode, perform the following:

- [Step 1] While holding down **SHIFT**, press Pad Key **5**.

```

METRONOME SET
$INTVL = 1 / 4
  
```

- [Step 2] Use **SELECT** to choose the parameter to be set.

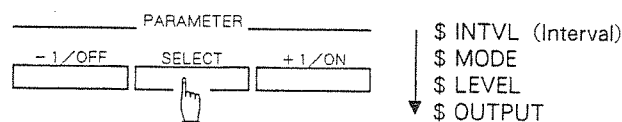

- [Step 3] Make the setting for the parameter using **-1/OFF**, **+1/ON**.
- [Step 4] When you wish to set other parameters as well, repeat Steps 2 and 3.
- [Step 5] Press **ENTER** to return to the original screen.

f. Setting Roll

The interval pertaining to the Roll can be changed.

With play stopped in the Song or Pattern mode, perform the following:

[Step 1] While holding down **SHIFT**, press Pad Key **11**.

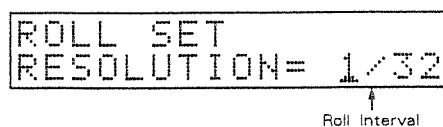

[Step 2] Using **-1/OFF**, **+1/ON**, set the interval for the Roll.
(Available settings: 1/4, 1/6, 1/8, 1/12, 1/16, 1/24, 1/32, 1/48, HIGH (1/96))

[Step 3] Press **ENTER** to return to the original screen.

g. Setting Flam

Settings are accepted, on an individual rhythm pattern basis, for the Flam Interval and Flam Ratio.

● Flam Interval

Setting that determines the interval of the flam.



Flam Interval

● Flam Ratio

This setting controls the ratio between the sound velocities of the first and second beats.

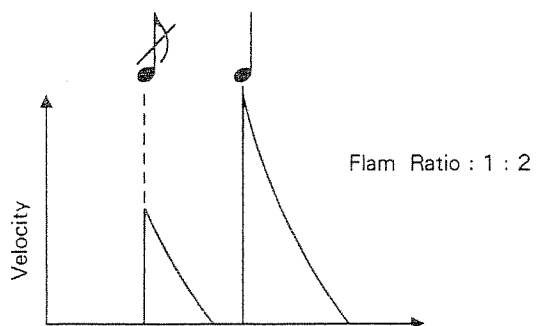

With play stopped in a Pattern mode (either "PLAY", "REAL", or "Step"), perform the following:

[Step 1] Select the number of the pattern for which Flam is to be set.

[Step 2] While holding down **SHIFT**, press Pad Key **7**.

```

FLAM SET <P00>
$INTVL= 15
  
```

↑ Flam Interval ↑ Value

[Step 3] Set the Flam Interval (0 - 31) using **-I/OFF**, **+I/ON**.
 * When set to 0, no flam is obtained.

[Step 4] Using **SELECT**, choose "RATIO".

```

FLAM SET <P00>
$RATIO=*1: 2*
  
```

↑ Flam Ratio ↑ Value

[Step 5] Set the Flam Ratio using **-I/OFF**, **+I/ON**.
 (Acceptable settings: 1 : 1, 1 : 2, 1 : 4, 1 : 8, 1 : 16, 1 : 32)

[Step 6] Press **ENTER** to return to the original screen.

2. Step Write

Provides for specifying for each instrument the timing at which it is to be sounded, and stores this information as a rhythm pattern.

a. Concept of Step Writing

In Step Writing, a measure is subdivided into a number of units referred to as "Steps". In building a rhythm pattern, the Steps, the timing at which sounds are produced, are specified on a per instrument basis.

For such divisions (the Steps), a Step Number is applied. Step Numbers come in order starting from the top of the measure.

For example, when one Step is a sixteenth-note, the divisions will occur so that at a time signature of 4/4, Steps will be numbered 1 to 16, and at 5/4, there will be Step numbers 1 through 20.

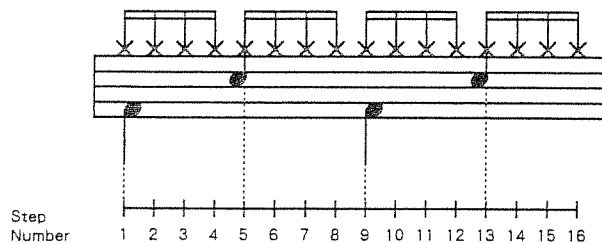

Length of a Step

Either of the following two Step Lengths can be chosen from, to match the rhythm pattern being created.

● Normal (NRM)

Each Step becomes a 16th note. (Quantize in Real-time Write of $Q=1/16$)

Selected such as when making rhythm patterns using 8 beat or 16 beat rhythms.

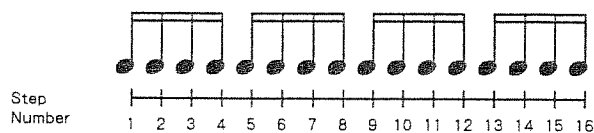

● Triplet (TRI)

Each Step becomes a triplet. (Quantize in Real-time Write of $Q=1/12$)

Useful for making rhythm patterns employing triplets.

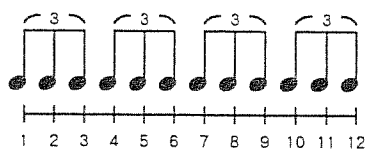

* During creation of a particular rhythm pattern, the length of a Step can be changed with play stopped.

Step Write Organization There are 3 screens available for use in input during Step Writing, as follows:

● **Basic Screen**

The Basic screen appears when, from the Pattern mode's Menu screen, you choose "Step".

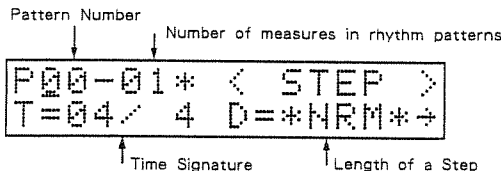

Here you select the number of the pattern to input to, specify Step length, and specify the number of measures to input the sounds (when there is to be a number of them). Also, creation of a simple rhythm pattern can be performed.

● **Write Screen**

Pressing **PAGE** from the Basic screen gives you the Write screen.

(Write Screen)

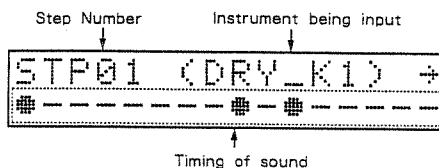

(Scope Screen)

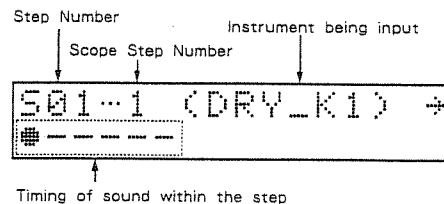

In the Write screen you can create rhythm patterns having unusual time signatures (such as 7/4). You can also view in the display the specified timing for sound to be produced, and instrument. In addition, through use of the Scope function, the timing at which notes are sounded can be specified in units equivalent to a 1/96th note. (Quantize in Real-time Write of Q=HIGH.)

● **Edit Screen**

Pressing **PAGE** from the Write screen gives you the Edit screen.

(Edit Screen)

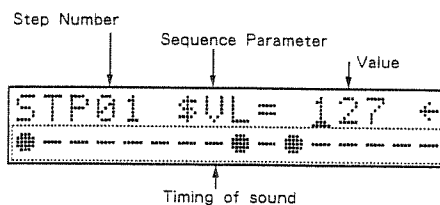

(Scope Edit Screen)

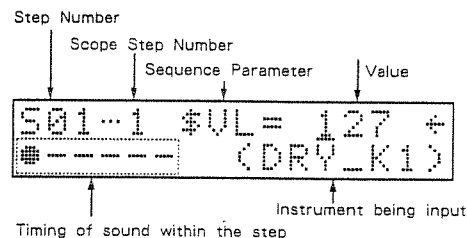

The sounds input to a rhythm pattern can be edited one note at a time. Through use of the Scope function, editing of sounds can be carried out in units equivalent to a 1/96th note. (Quantize in Real-time Write of Q=HIGH.) Also, rhythm patterns can be created using the same procedure as used in the Write screen.

* For procedures used in the Edit screen, see page 61.

b. Initial Settings

Select the number of the pattern to input to (00 - 99), and specify the time signature and number of measures.

[Step 1] Press **PATTERN** to select the Pattern mode.

```

PLAY      STEP
REAL      PRESET
    
```

* Should the Menu screen not appear, press **EXIT**.

[Step 2] Press **2** in the Numerical Keys to specify "Step".

↓ Pattern Number

```

P00-01* < STEP >
T=04/ 4 D=*NRM*+
    
```

[Step 3] Choose the pattern number (00 to 99) using **-1/OFF**, **+1/ON**.

The display will respond as shown below when the selected rhythm pattern contains performance data.

Indicates there is performance data in rhythm pattern

↓

```

P01-01↓ < STEP >
T=04/ 4 D=*NRM*+
    
```

To edit the selected rhythm pattern, continue on to "c. Input of Sound".
 (No changes can be made in the time signature or number of measures for rhythm patterns already containing performance data.)

[Step 4] While holding down **SHIFT**, press Pad Key **10**.

(When there is performance data)

```

PTN CLEAR <P00>
INST=ALL
    
```

(When there is no performance data)

```

PTN FORMAT <P00>
T= 04/ 4 BAR= 01
    
```

When you have selected a rhythm pattern containing performance data, press **ENTER** to erase all data there.

* To abort the procedure, press **EXIT**.

[Step 5] Using **-1/OFF**, **+1/ON** specify the number of measures (1 - 99) the rhythm pattern is to have.

```
PTN FORMAT <P00>
T= 04/ 4 BAR= 01
```

↑ Time Signature ↑ The number of measures

[Step 6] Set the time signature for the rhythm pattern.

Position the cursor using **◀** **▶** to the number to be set, and set with **-1/OFF**, **+1/ON**.

(Available settings: 1/4 - 8/4, 1/6 - 12/6, 1/8 - 16/8, 1/12 - 24/12, 1/16 - 32/16, 1/24 - 48/24, 1/32 - 64/32)

[Step 7] Press **ENTER** to return to the Step Write screen.

c. Input of Sound

Following "b. Initial Settings", p. 38, the next Steps are performed.

1) Fundamental Step Write





Here explained is the procedure for Step-Write from the Basic screen.

[Step 1] When you are going to start input from a measure lying partway through a rhythm pattern having multiple measures, specify the measure to input from.

Using **◀** **▶** move the cursor to the measure number position, and specify the measure using **-1/OFF**, **+1/ON**.

```

      ↓ Measure to input
P00-03* < STEP >
T=04/ 4 D=*NRM*+
```

[Step 2] Select the length of a Step.
 Position the cursor, using  , at the value set for "D=". Then select the length for 1 Step using , .

NRM:1 Step is a 16th note



TRI:1 Step is a triplet

[Step 3] With play stopped, press the Pad Key for the instrument to be input.
 When necessary, press  to change Pad Banks.

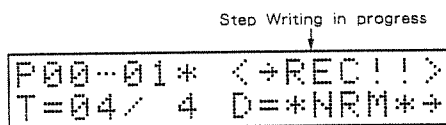
[Step 4] Press  to start play.



* Once play is started, Pad Keys 1 through 16 then serve as keys used for specifying the timing of sound production (Step Numbers).

[Step 5] Specify the timing of sound play (Step Number) by tapping the Pad Keys (-).
 At this time, the strength with which the Pad Keys are struck is also input.

* The same Pad Key can be tapped a second time to erase the sound that will occur there.
 The sounds can also be erased using the same procedure as in "● To carry out complete erasure", p. 32.

All sounds that have been input will be repeatedly played for the set number of measures.

[Step 6] To carry out input for other instruments, first stop play, then repeat Steps 3 through 5.

[Step 7] With rhythm patterns having multiple measures, repeat Steps 1 through 6.

[Step 8] Stop play, then press  to return to the Menu screen.

● Inputting Flam

Flam is a performance technique whereby the two sticks are made to hit the snare or other drum at almost the same instant, except that one diverges slightly in terms of timing and velocity.

To input the flam effect, perform the procedure as follows while in Step Write, and with play started.

[How] While holding down **FLAM**, press the Pad Key corresponding to the Step (or Scope Step :see p.43) where flam is to be applied.

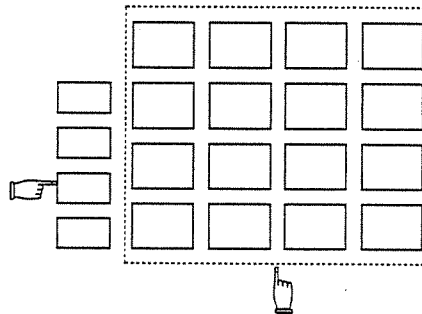

Input for flam can be checked using the Write screen (see next page).

(Write Screen)

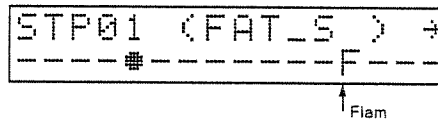

* To change the setting affecting Flam, carry out the Steps on page 34.

2) Step Write in the Write Screen

Here explained are the procedures used in creating rhythm patterns in the Write screen; those which cannot be made using the Basic screen. The methods used for input are basically the same, except that in the Write screen you can create patterns using a time signature that is less ordinary, such as 5/4, and produce a number of Steps in excess of 16 per measure.

[Step 1] Press **PAGE** in the Basic screen to choose the Write screen.

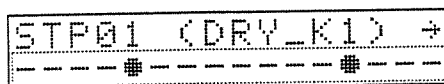

Currently specified timing of sound is displayed
(In this case, Step Number 5 and 13 specified)

When the number of Steps in 1 measure goes beyond 17 (when 1 Step is a triplet, beyond 13), "▶" will appear in the display to the right of the Step Number.

Step Numbers not currently displayed exist

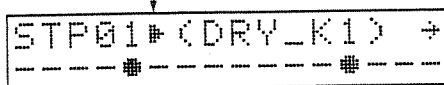

[Step 2] Pressing **▶** repeatedly to increment the Step Numbers.

If you hold down **▶** (**◀**) while pressing **◀** (**▶**), you can move more rapidly through change of the Step Numbers.

When the Step Number exceeds 16 (when 1 Step is a triplet, 12), the correspondence between Pad Keys and Step Numbers changes, and "◀" is displayed to the right of the Step Number.

Correspondence between Pad keys and Step Numbers
(When 1 Step is a 16th note, and the time signature is 5/4)

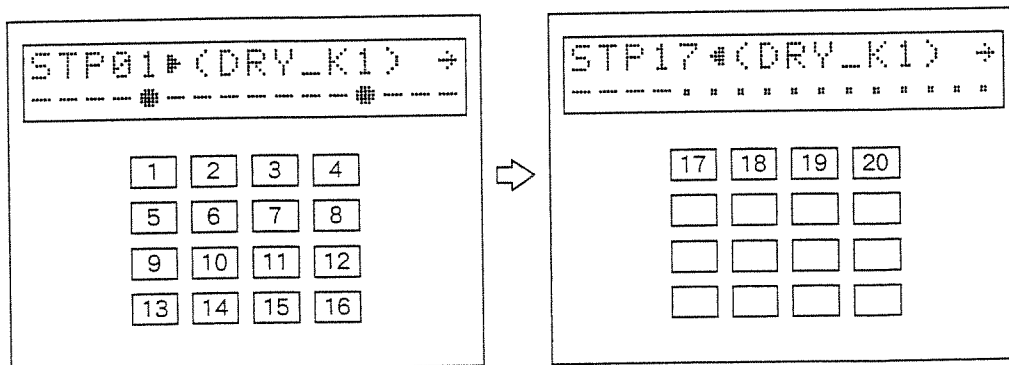

* When a pattern consists of multiple measures, the progression through Step Numbers using **▶** takes you into the next measure.

[Step 3] With play started, specify the timing for producing sound (Step Number) by tapping the Pad Keys (**I**-**16**).

At this time, the strength with which the Pad Keys are struck is also input.

To select other Instrument, first stop play, then press the Pad Key.

● Scope Function

Using the Scope function, the timing of sounds can be set in units of 1/96th notes (Quantize in Real-time Write of Q="HIGH").

Specify in the Write screen the number of the Step which is to be input at more precise timing, and the timing between that Step and the next is specified in Scope Step units (1/96th notes).

At this time, the manner in which Scope Steps are divided will vary depending on the setting for the length of 1 Step.

(When 1 Step is a 16th note)

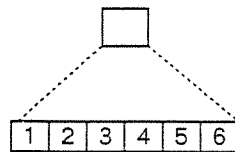

Scope Step Number

(When 1 Step is a triplet)

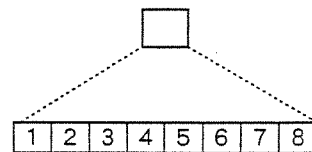

Scope Step Number

Since 1 Scope Step is a 96th note, the resulting division into Scope Step Numbers will be 1 to 6 when one Step is a 16th note (NRM), and 1 to 8 when one Step is a triplet.

To use the Scope function, perform the following Steps from the Write screen:

[Step 1] With play stopped, select the instrument to be input.

[Step 2] Using **◀ ▶**, select the Step Number for which timing is to specified.

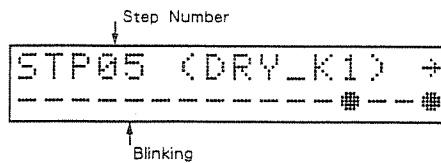

[Step 3] Press **SCOPE** to select the Scope screen.

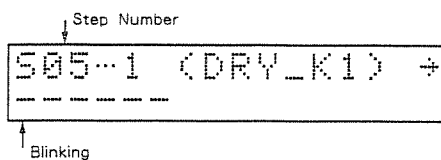

[Step 4] Start play, and specify the Scope Step Numbers by tapping Pad Keys **[1]-[6]** (**[1]-[8]** when one Step is a triplet).

The strength of your tapping is also registered at this time.

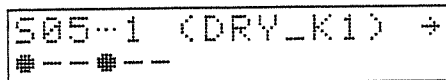

Timing of sound with Scope Steps

* Tap the same Pad Key again to erase what was input.

* By pressing **[▶]** in the Scope screen and progressing through Scope Step Numbers, you eventually move into the next Step Number.

If you hold down **[◀]** (**[▶]**) while pressing **[▶]** (**[◀]**), you can move more rapidly through change of Scope Steps.

[Step 6] Press **[SCOPE]** to return to the Write screen.

[Step 7] To specify Scope Steps for another Step Number, repeat Steps 2 through 6.

The current status of settings for Scope Steps can be checked in the Write screen.

Sign	Scope Step Number setting	Description
--	-----	No sound is entered in the Step Number currently shown in the display.
●	●-----	A Sound is entered in Scope Step Number 1.
●	●---●--- ●---●--- etc.	Sounds are entered in the Scope Step Number 1 and other Scope Step Numbers.
F	F-----	Flam sound is entered in Scope Step Number 1.
F	F---●--- F---F--- etc.	Flam sound is entered in Scope Step Number 1 and sounds are entered in other Scope Step Numbers.
※	---●--- ---F---●--- etc.	Sounds are entered in the Scope Step Numbers differently from the above settings.

● Index Search Function

This function provides for rapid selection of an instrument to be input during the Step Write process.

The function is obtained while stopped in either the Write or Scope screens.

[How]

Press **-1/OFF**, **+1/ON**.

You are able to make selection of the instruments currently used in the rhythm pattern.

* If you hold down **SHIFT** while pressing **+1/ON** (or **-1/OFF**), you can select the next higher (or lower) numbered instrument.

Press **SELECT** to listen to the selected instrument.

2. Playing Rhythm Patterns

1. Playing Programmable Patterns

The following allows play of rhythm patterns created through Pattern Writing.

[Step 1] Press **PATTERN** to enter the Pattern mode.

[Step 2] Press Numerical Key **1** to specify "PLAY".

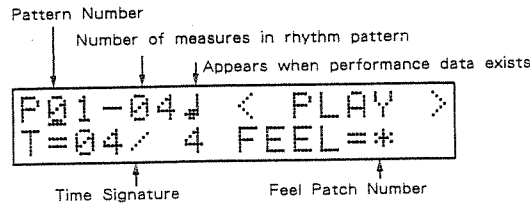

[Step 3] Select a pattern number (00 to 99) using **-1/OFF**, **+1/ON**.

When a rhythm pattern having multiple measures is selected, play can be started from any measure partway through as well. In such cases, use **◀ ▶** to position the cursor at the measure number, and specify the desired measure number using **-1/OFF**, **+1/ON**.

[Step 4] Press **START/STOP** and repetitive play of the rhythm pattern will begin.

To start play from a measure partway through, hold down **SHIFT** while pressing **START/STOP**.

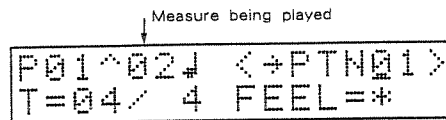

[Step 5] To play another rhythm pattern, repeat Step 3.

The number of the pattern selected is displayed, and it will afterwards start playing following the rhythm pattern that is currently playing.

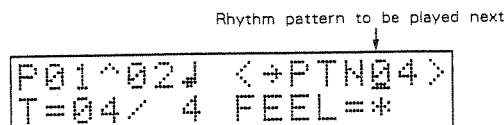

[Step 6] Press **START/STOP** and play will stop.

[Step 7] Press **EXIT** to return to the Menu screen.

2. Play of Preset Patterns

The R-5 is provided with 32 types of basic Preset Patterns (stored in Preset Pattern Numbers 00 - 31).

* For information on the types of Preset Patterns, see p. 188.

* Should you wish to use any Preset Patterns in a song, use Pattern Copy (p. 54) to first copy them into a programmable pattern. As a result of copying them into a programmable pattern, the patterns can then be altered and used in forming new rhythm patterns.

[Step 1] Press **PATTERN** to enter the pattern mode.

[Step 2] Press Numerical Key **4** to specify "PRESET".

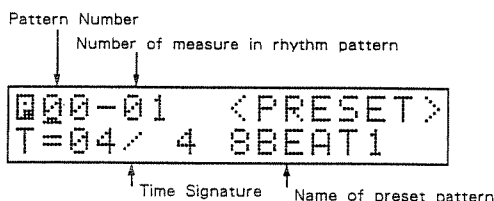

[Step 3] Select the number (00 - 31) of a Preset Pattern (00 - 31) using **-1/OFF**, **+1/ON**.
When a rhythm pattern having multiple measures is selected, play can be started from any measure partway through as well. In such cases, use **◀ ▶** to position the cursor at the measure number, and specify the desired measure number using **-1/OFF**, **+1/ON**.

[Step 4] Press **START/STOP** and repetitive play of the rhythm pattern will begin.
To start play from a measure partway through, hold down **SHIFT** while pressing **START/STOP**.

[Step 5] Press **START/STOP** and play will stop.

When wishing to play another Preset Pattern, with play stopped repeat Steps 3 and 4.

[Step 6] Press **EXIT** to return to the Menu screen.

3. Editing Rhythm Patterns

1. Rhythm Pattern Editing

a. Instrument Change

You can change instruments after they have been input into a rhythm pattern using the following procedure.

The following Steps are carried out with play stopped, from a Pattern mode (either "PLAY", "REAL", or "Step").

[Step 1] Select the number of the pattern for which you wish to change instruments.

[Step 2] While holding down **SHIFT**, press Pad Key **I**.

```
INST CHANGE<P00>
DRY_K1>>(*****)
```

↑
Instrument contained in the rhythm pattern

[Step 3] Using **-1/OFF**, **+1/ON** specify the instrument you want to change. The instruments used in the rhythm pattern will be displayed one after the other.

* Press **SELECT** to listen to the instrument selected.

* When there is no performance data in the rhythm pattern selected, "*****" will be displayed.

[Step 4] Specify the instrument to be newly set by tapping the corresponding Pad Key.

Use **PAD BANK** to change Pad Banks when necessary.

* If you hold down **SHIFT** while pressing **+1/ON** (or **-1/OFF**), you can select the next higher (or lower) numbered instrument. Also, if you hold down **SHIFT** and press **SELECT**, you can audition the selected instrument.

[Step 5] Press **ENTER**.

"Completed" will appear, indicating the instrument has been changed.

* Press **EXIT** when you want to cancel the procedure.

b. Pattern Append

This function allows you to link together (Append) 2 rhythm patterns, so they combine as one pattern. When you plan on using the same combination of rhythm patterns several times in a song, it is more efficient if you use Append beforehand.

< Ex. > Rhythm Pattern 2 is appended to Rhythm Pattern 1.

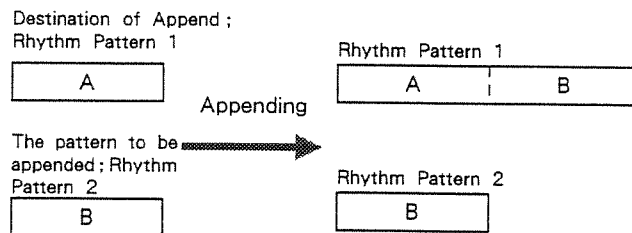

- * Rhythm patterns of differing time signatures cannot be appended.
- * Regarding settings for Swing/Flam/Feel Patch, the rhythm pattern selected in Step 3 will take priority.
- * Append cannot be performed when the resulting rhythm pattern will total more than 99 measures.

The following Steps are carried out with play stopped, from a Pattern mode (either "PLAY", "REAL", or "Step").

[Step 1] Select the number of the pattern to be appended.

[Step 2] While holding down **SHIFT**, press Pad Key **2**.

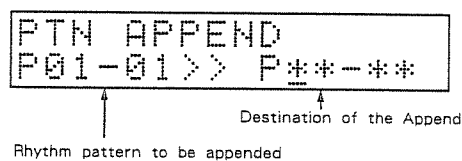

[Step 3] Select the number of the pattern becoming the destination for the append, using **-1/OFF**, **+1/ON**.

- * When you press **+1/ON** (or **-1/OFF**), the next higher (or lower) pattern number will appear in the display.

[Step 4] Press **ENTER**.

"Completed" will appear, indicating the Append has been performed.

- * To cancel the procedure, press **EXIT** instead.

c. Pattern Extract

This function allows you to take the performance data for any single instrument only (Extract) from a pattern, and copy it to another pattern.

This is convenient when wanting to use an identical pattern using the same instrument for numerous patterns.

< Ex.>The performance data of Rhythm Pattern 1 (hi-hat) is extracted to Rhythm Pattern 2.

The pattern to be extracted ;
Rhythm Pattern 1

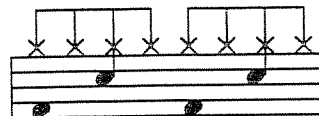

Destination of Extract ;
Rhythm Pattern 2



Extracting
→

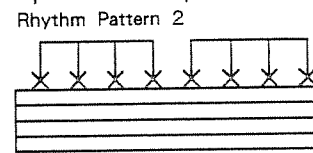
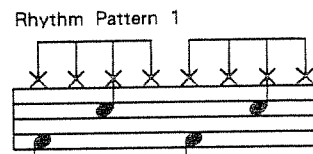

Carry out the following Steps with play stopped, from a Pattern mode (either “PLAY”, “REAL”, or “Step”).

[Step 1] Select the number of the pattern to be extracted.

[Step 2] While holding down **SHIFT**, press Pad Key **3**.

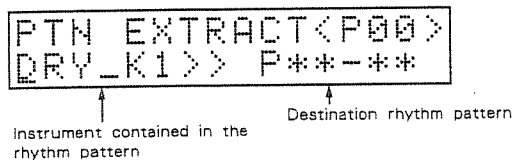

[Step 3] Specify the instrument to be extracted, using **-1/OFF**, **+1/ON**.

The instruments used in the rhythm pattern will appear in turn.

* The instrument selected can be listened to by pressing **SELECT**.

[Step 4] Use **▶** to position the cursor at “P * * - * *”, then select the number of the pattern becoming the destination of the copy using **-1/OFF**, **+1/ON**.

* When you press **+1/ON** (or **-1/OFF**), the next higher (or lower) pattern number will appear in the display.

[Step 5] Press **ENTER**.

When there is no data in the destination pattern, the copy takes place, and “Completed” is displayed. When there is existing data at the destination pattern Number, “Overwrite OK?” will be displayed. To continue and perform the copy, press **ENTER** again. To cancel the operation, press **EXIT** instead.

* Any previous data contained at the copy destination will be erased.

d. Pattern Merge

This function combines one pattern on top of another (Merges it), to form a single rhythm pattern.

< Ex. > Rhythm pattern 2 is merged with Rhythm Pattern 1.

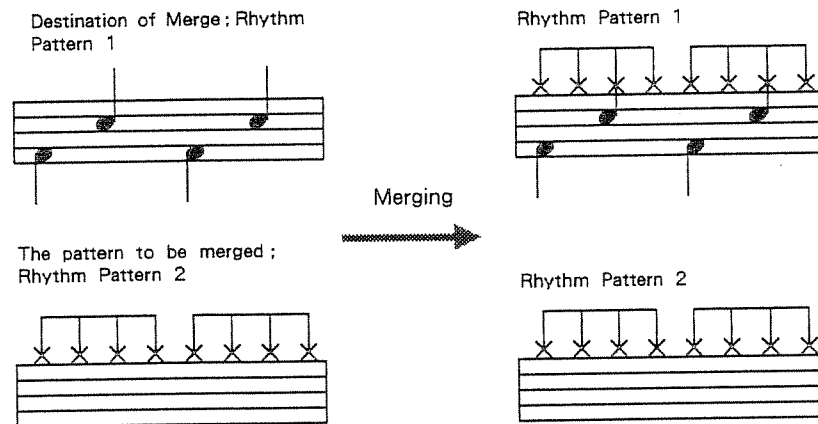

- * Rhythm patterns of differing time signatures or number of measures cannot be merged.
- * The rhythm pattern becoming the destination takes priority with regard to settings for Swing/Flam/Feel Patch.

The following Steps are carried out with play stopped, from a Pattern mode (either "PLAY", "REAL", or "Step").

[Step 1] Select the number of the pattern to be merged.

[Step 2] While holding down **SHIFT**, press Pad Key **4**.

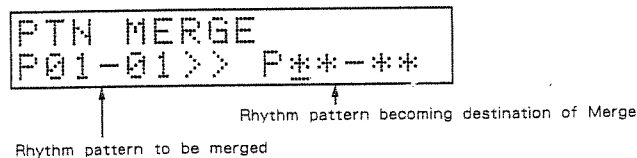

[Step 3] Select the pattern number becoming the destination for the Merge using **-1/OFF**, **+1/ON**.

- * When you press **+1/ON** (or **-1/OFF**), the next higher(or lower) pattern number will appear in the display.

[Step 4] Press **ENTER**.

"Completed" will be displayed, indicating the Merge has been performed.

- * To cancel the procedure, press **EXIT** instead.

e. Reframe

This function allows you to specify a start point lying partway through a rhythm pattern, and then move all data coming after it to the beginning.

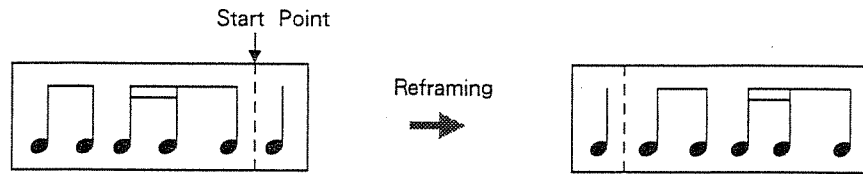

This is convenient for making revisions when, in Real-time Write, the timing of what was first input was somewhat off.

Carry out the following Steps with play stopped, from a Pattern mode (either “PLAY”, “REAL”, or “Step”).

[Step 1] Select the number of the pattern to be reframed.

[Step 2] While holding down **SHIFT**, press Pad Key **8**.

```
PTN REFRAME<P00>
BAR= 01 CLK= 000
```

↑ Measure to start from ↑ Clock Number

When the rhythm pattern has only 1 measure, skip to Step 4.

[Step 3] Specify the measure to start from, using **-1/OFF**, **+1/ON**.

[Step 4] Using **◀ ▶** move the cursor to the right. Then using **-1/OFF**, **+1/ON**, specify in terms of Clock the distance from the beginning of the measure where you wish to start. (1 Clock = 96th note) In the example in the above illustration, there are quarter notes for 2 beats, so it is set to CLK= 048.

[Step 5] Press **ENTER**.

“Completed” will be displayed, indicating the Reframe has been performed.

* To cancel the procedure, press **EXIT** instead.

f. Pattern Copy

This function allows you to copy any programmed rhythm pattern or Preset Pattern to another pattern number. You can also copy only specific measures from a pattern if you wish.

This can be effectively used to copy a rhythm pattern several times and then edit them when you are planning on forming a number of rhythm patterns that are fairly similar.

< Ex.> Rhythm Pattern 1 is copied to Rhythm Pattern 2.

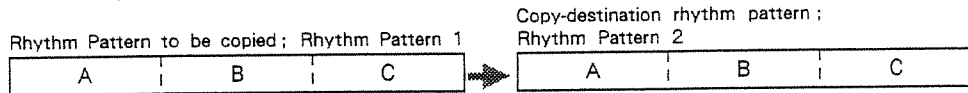

< Ex.> The 2nd measure of Rhythm Pattern 1 is copied to Rhythm Pattern 2.

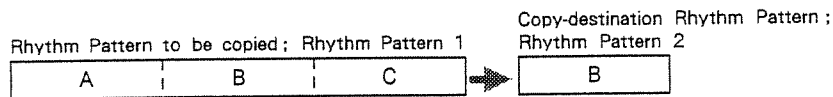

To copy a programmable pattern, the function is accessed from a Pattern mode (either “PLAY”, “REAL”, or “Step”) with play stopped. To copy a Preset pattern, you need to be at the stage where play of “PRESET” has been stopped. In either case, proceed then with the following Steps:

[Step 1] Select the number of the pattern to be copied.

[Step 2] While holding down **SHIFT**, press Pad Key **9**.

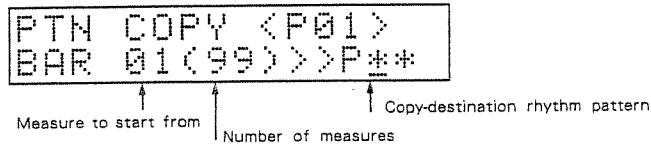

[Step 3] Select the number of the destination pattern using **-1/OFF**, **+1/ON**.

* When you press **+1/ON** (or **-1/OFF**), the next higher (or lower) pattern number will appear in the display.

* To copy the rhythm pattern as a whole, skip to Step 5.

[Step 4] Use **◀** **▶** to move the cursor, and then with **-1/OFF**, **+1/ON** specify the measure the copy is to start from, and the number of measures.

[Step 5] Press **ENTER**.

When there is no data in the destination pattern, the copy takes place, and “Completed” is displayed. When data already exists at the destination pattern, “Overwrite OK?” will be displayed. To continue and perform the copy, press **ENTER** again. To cancel the operation, press **EXIT** instead.

* All performance data formerly at the destination of the copy will be erased.







* When the number of measures specified to be copied are in excess of the number actually in the pattern, copy takes place through to the final measure in the pattern.

g. Swing

Swing is an effect that adds bounce to the way a piece is actually performed, even though the notation calls for identical notes. Settings controlling Swing can be made for each rhythm pattern, and consist of a Swing Point and Swing Delay.

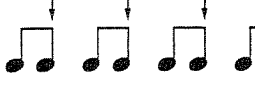
● Swing Point

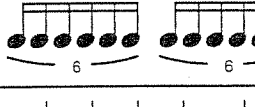
The Swing effect is achieved by delaying the timing that sounds are produced for specific beats in a rhythm pattern. This point, the beat at which sound is delayed, is set as the Swing Point. With a Swing Point set, sounds of the following timing are delayed:

Swing Point	Timing with sound delayed
1/4	
1/6	
1/8	
1/12	
1/16	
1/24	
1/32	

● Swing Delay

Sets the amount by which the timing of the sound is delayed.

Setting Swing

Carry out the following Steps with play stopped, from a Pattern mode (either “PLAY”, “REAL”, or “Step”).

* The Swing effect can be obtained with either Pattern or Song Play, but not while using Pattern Write.

[Step 1] Select the number of the pattern for which Swing is to be set.

[Step 2] While holding down **SHIFT**, press Pad Key **6**.

```

SWING SET <P01>
$DELAY= 00
  
```

↑ Swing Delay ↑ Value

[Step 3] Set the delay for the Swing using **-1/OFF**, **+1/ON**.

The higher the value set, the greater will be the bounce effect. At 0, no effect for Swing is obtained.

* The possible range for setting Swing Delay will vary depending on the setting made for Swing Point.

[Step 4] Press **SELECT** and choose “POINT”.

```

SWING SET <P01>
$POINT= 1/8
  
```

↑ Swing Point ↑ Value

[Step 5] Set the Swing Point using **-1/OFF**, **+1/ON**.

(Available settings : 1/4, 1/6, 1/8, 1/12, 1/16, 1/24, 1/32.)

[Step 6] Press **ENTER** to return to the original screen.

2. *Editing the Sequence Parameters*

Each sound contained in a rhythm pattern can have individual settings for its Sequence Parameters (Velocity, Pitch, Decay, Nuance, Pan) which shape its sound. This allows revision of an accent used when inputting a sound, or for one instrument within a pattern to be played at a different timbre.

For parameters other than Velocity, the values set for the Performance Parameters (p. 92) of the Pad Keys when the pattern was written will be input as the Sequence Parameters.

How Sequence Parameters work

The values set for the Sound Parameters form the basis for all of these parameters, except for Velocity. When a rhythm pattern or song is played, the sound is generated at values which consist of those of the Sound Parameters and Sequence Parameters combined.

For detailed explanation of these parameters, see page 91.

● **Velocity (1 – 127)**

This parameter represents the strength used when tapping the Pad Key during Pattern Writing. The higher the value, the more the sound reaches a level obtained if you hit the Pad Key harder.

● **Pitch (-4800 – +4800 cents)**

Pitch can be set in units of 10 cents. (1 semitone = 100 cents)
Higher values produce a higher pitch.

* At 0 the Pitch matches that of the Sound Parameters.

● **Decay (-63 – +63)**

Sets the amount of decay for the sound.
Higher values produce a longer decay.

For instruments accepting settings for Nuance, the value is added to each Decay. (see p. 94)

* At 0 the Decay is identical to that of the Sound Parameters.

● **Nuance (-7 – +7)**

Through changes in Nuance, subtle variations in timbre can be obtained. (see p. 95)

* With instruments not accepting settings for Nuance, the timbre will not change, no matter what the setting.

* At a setting of 0, the Nuance is identical to that of the Sound Parameters.

● **Pan (L1 -3/ C / R1 - 3/ OFF)**

With instruments assigned Stereo Output for their Sound Parameters, setting can be made for Pan (orientation of sound image).

- * When a value differing from that of the Sound Parameters is set, the value for the Sequence Parameters have priority. At OFF the orientation becomes that of the Sound Parameter.
- * No change in the orientation will be obtained by a Pan setting with instruments assigned Multi Output for their Sound Parameters.

Editing Process

Two methods, as follows, can be used for editing the Sequence Parameters.

● **Real-time Editing**

Controls such as the VALUE slider are used to change values while the pattern is playing.

● **Step Editing**

Each sound can be individually chosen and its value can be changed.

More precise editing can be performed in comparison with Real-time Editing.

- * The timbre of an instrument will change only to the extent determined by the range of the settings for the Sound Parameters. Therefore, when the value obtained as a result of adding the Sequence Parameters to the Sound Parameters exceeds the allowable range, no further change is obtained.

a. Real-time editing

* Provides for editing of the Sequence Parameters of the instruments currently having an assignment relative to the Pad Keys. If you wish to edit an instrument not yet assigned, first assign it to a Pad Key. (page 88)

With play stopped perform the following Steps:

[Step 1] Press **PATTERN** to enter the Pattern mode.

[Step 2] Press **3** in the Numerical Keys to select "REAL".

[Step 3] Select the number of the pattern for which Sequence Parameters are to be edited.

[Step 4] Press **PAGE** to select the Real-time Edit screen.

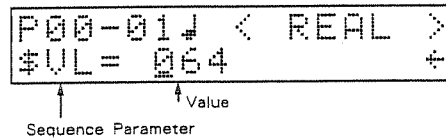

[Step 5] Using **SELECT**, choose the Sequence Parameter that is to be edited.

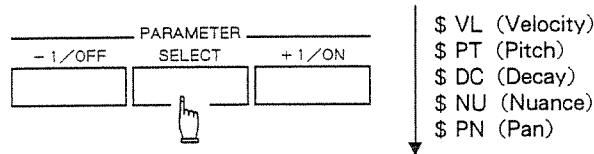

[Step 6] Change the value of the parameter using **-1/OFF**, **+1/ON**.

When making continuous changes in the value, use the VALUE slider to set the basic, initial value.

[Step 7] Press **START/STOP** to start play.

[Step 8] Press the Pad Key corresponding to the instrument you wish to edit.
The Sequence Parameters of the sound played while the Pad Key is pressed can be changed.

If the VALUE slider is moved while the Pad Key is pressed, consecutive changes in the value can be made.

[Step 9] To edit other parameters, repeat Steps 5 through 8.

[Step 10] Press **START/STOP** to stop play.

[Step 11] Press **EXIT** to return to the Menu screen.

b. Step Edit

Perform the following Steps with play stopped:

- [Step 1] Press **PATTERN** to enter the Pattern mode.
- [Step 2] Press **2** in the Numerical Keys to specify "Step".
- [Step 3] Select the number of the pattern for which the Sequence Parameters are to be edited.
- [Step 4] Press **PAGE** twice to get to the Edit screen.

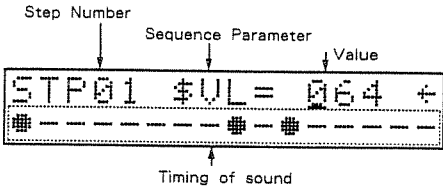

- [Step 5] Press the Pad Key for the instrument you wish to edit. If necessary, use **PAD BANK** to change Pad Banks.
- [Step 6] With **SELECT**, choose the parameter to edit.

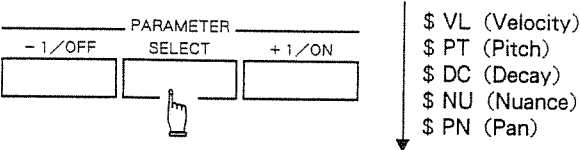



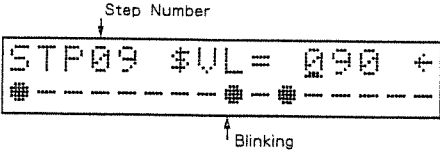

* If you want to monitor the sound while editing, press **START/STOP** to have it play.

- [Step 7] Select the Step Number to edit with **◀ ▶**, and change the value using **-1/OFF**, **+1/ON**.



* No change can be made in the value of Step Numbers (or Scope Steps) that contain no sound. (" * * " displayed for value set)

* If you press  (or ) while also pressing  (or ) the Step Numbers can be changed more rapidly.

[Step 8] To edit other parameters, repeat Steps 6 and 7.

[Step 9] To edit other instruments, first stop play, then repeat Steps 5 through 8.

[Step 10] Press **START/STOP** to stop play.



[Step 11] Press **EXIT** to return to the Menu screen.

Scope Function

By using the Scope function, the Sequence Parameters of sounds that have been input can be edited in units equivalent to a 1/96th note.

This is accessed by performing the following Steps from the Edit screen.

[Step 1] With play stopped, press the Pad Key for the instrument you wish to edit. If necessary, use **PAD BANK** to change Pad Banks.

[Step 2] Using   select the number of the Step you wish to edit in Scope units.



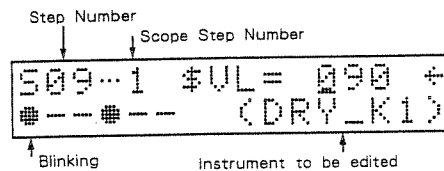

[Step 3] Press **SCOPE** to get the Scope Edit screen.



* In the Scope Edit screen, if you hold down **SHIFT** while pressing **+1/ON** (or **-1/OFF**), you can select the next higher (or lower) numbered instrument. Also, if you hold down **SHIFT** and press **SELECT**, you can hear the selected instrument.





[Step 4] With **SELECT**, choose the parameter to edit.

If you want to monitor the sound while editing, press **START/STOP** to have it play.

[Step 5] Select the number of the Scope Step to edit with  , and change the value using , .

* No change can be made in the value of Scope Step Numbers that contain no sound.
(“* *” displayed for value set)

* When by pressing , you continue progressing through Scope Step Numbers in the Scope Edit screen, you eventually will move into the next Step Number.

If you press  (or ) while also pressing  (or ) the Scope Steps can be changed more rapidly.

[Step 6] To edit other parameters, repeat Steps 4 and 5.

[Step 7] Press  to return to the Write screen.

[Step 8] To edit the Scope Steps in another Step Number, repeat Steps 2 through 7.

* Even while in an Edit screen, rhythm patterns can be created using the same procedures you would in the Write screen (see page 42).

Songs

1	<i>Creation of a Song</i>	<i>P.66</i>
2	<i>Playing a Song</i>	<i>P.75</i>
3	<i>Song Editing</i>	<i>P.80</i>

1. Creation of a Song

The rhythm patterns (programmable patterns) you have built using Pattern Writing are now combined to form all the rhythms for one song, by linking them in the order they are to be played. Up to 6 such songs can be created, and for each one settings can be made that will determine the tempo or level to be used when they are played.

Data Written to Songs

In addition to rhythm patterns, Repeat/ Tempo Change/ Level Change/ and Label are also written to each song.

●Repeat

Repeats play of a specified rhythm pattern.

●Tempo Change

Changes the tempo to be played at starting from a specified rhythm pattern.

●Level Change

Changes the level to be played at (overall level) starting at a specified rhythm pattern.

●Label

At places during the course of a song, Labels (up to 4 characters) can be placed to serve as reminders. Then, the Search Label function allows you to move rapidly to a desired Label position.

Song Composition

All such song data as above, as well as rhythm patterns, form units referred to as "Parts", which are written into a song. Every Part inserted in a song is numbered in order, from the top of the song. Any one song can contain up to a maximum of 999 Parts.

Part Number	001	002	003	004	005	006	007	008	009
Song Data	Rhythm Pattern 01	Rhythm Pattern 02	Tempo Change	Repeat ● ●	Rhythm Pattern 04	Repeat ● × 1	Label	Level Change	Rhythm Pattern 10

1. Basic Song Writing

The following outlines the methods used in writing rhythm patterns to a song.

* Preset patterns cannot be written in unchanged form to a song. If you wish to employ the Preset Patterns, first copy them into a programmable pattern (see page 54).

[Step 1] Press **SONG** to enter the Song mode.

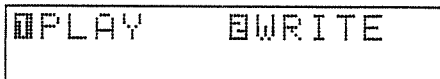

* Should the Menu screen fail to appear, press **EXIT**.

[Step 2] Press **1** in the Numerical Keys to select "PLAY".

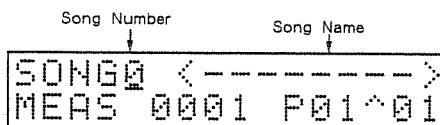

[Step 3] Select a song number (0 - 5) using **-1/OFF**, **+1/ON**.

When there is no performance data at the song number you select, " * * * " will be displayed at the value of "MEAS" and "P".

* When there is data already contained at the song number you have selected, first erase all data there using Song Clear (see p. 85).

[Step 4] Press **EXIT** to return to the Menu screen, then press **2** in the Numerical Keys to specify "WRITE".

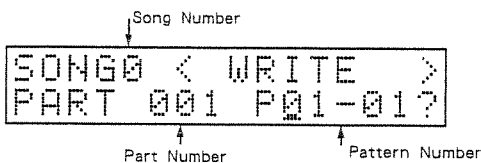

* The song number cannot be changed in the Song Write screen.

[Step 5] Select the number (00 to 99) of the pattern to write using **-1/OFF**, **+1/ON**.

```
SONG0 < WRITE >  
PART 001 P33-01?
```

↑ Indicates this rhythm patterns is no yet written into a song

Press **START/STOP** to listen to the selected pattern.

* If in this screen you press **SELECT**, you will be able to choose song data other than that of the rhythm pattern. For information on making settings for the various types of data, refer to Repeat (p. 70), Tempo Change (p. 71), Level Change (p. 72), and Label (p.73).

[Step 6] Press **ENTER**.

```
SONG0 < WRITE >  
PART 002 P33-01?
```

The rhythm pattern is written to the song, and the Part number will advance by one.

[Step 7] Repeat Steps 5 and 6 until all data down to the last measure has been written.

[Step 8] If a rhythm pattern is playing, stop it.

[Step 9] Press **EXIT** to return to the Menu screen.

Changing a Pattern Number

When you wish to afterwards change the number of a pattern that has been written to a song, perform the following Steps while in the Song Write screen.

[Step 1]

Using **◀** **▶** specify the Part with the pattern number you wish to change.

If you press **◀** (or **▶**) while also pressing **▶** (or **◀**) the Part numbers can be changed more rapidly.

```
SONG0 < WRITE >
PART 009 P03-01
```

↑
Specified Part Number

↑
Rhythm pattern written into a Part

[Step 2]

Select the number (00 to 99) of the new pattern using **-1/OFF**, **+1/ON**.

* Song data other than that of rhythm patterns can be selected using **SELECT**. For information on settings for various types of data, refer to Repeat (p. 70), Tempo Change (p. 71), Level Change (p. 72), and Label (p. 73).

[Step 3]

Press **ENTER**.

With this procedure, the new rhythm pattern replaces the previous one.

[Step 4]

If necessary, repeat the procedures.

* To delete Parts, or insert new ones, refer to Song Editing, page 80.

2. Settings for Song Data and How They Work

The functions of and settings made for Repeat/ Tempo Change/ Level Change/ and Label will be explained while listing rhythm patterns, and using the various methods of writing song data.

* When song data is to be added after a rhythm pattern has been written, use Part Insert (see p. 81).

a. Repeat

Repeats play of specified rhythm patterns.

Repeat is set in terms of a starting Part (|| :) and ending Part (: ||), as well as the number of repetitions.

Song Data	Rhythm Pattern A	Repeat : •	Rhythm Pattern B	Rhythm Pattern C	Repeat • x 1	Rhythm Pattern D	Rhythm Pattern E
Song Playing	Rhythm Pattern A	Rhythm Pattern B	Rhythm Pattern C	Rhythm Pattern B	Rhythm Pattern C	Rhythm Pattern D	Rhythm Pattern E

Carry out the following Steps from the Song Write screen.

[Step 1] Before writing the rhythm pattern from which repeat is to start, first press **SELECT** to choose "|| :".

```
SONG0 < WRITE >
PART 017 || ?
```

[Step 2] Press **ENTER**.
The Repeat Part (|| :) is written.

[Step 3] Write the rhythm pattern being repeated.

[Step 4] Press **SELECT** and choose ": || x 01". Then using **-1/OFF**, **+1/ON** set the number of repetitions (1 - 99).

```
SONG0 < WRITE >
PART 022 || x01 ?
```

↑
Number of Repeats

[Step 5] Press **ENTER**.
The Repeat Part (: || x 01) is written.

* Inside a set of Repeat symbols, you can further make setting for up to 8 other sets of Repeats. When more than 8 sets of Repeats are nested inside each other, those deepest inside are given priority over those on the exterior.

b. Tempo Change

The tempo can be changed while a song is playing.

When a Tempo Change is set as a Part in the song, the Tempo Change takes effect from the rhythm pattern at the next Part.

Song Data	Rhythm Pattern A	Rhythm Pattern A	Tempo Change + 10	Rhythm Pattern B	Rhythm Pattern C
Song Playing	Rhythm Pattern A	Rhythm Pattern A	Rhythm Pattern B	Rhythm Pattern C	
Tempo	120	120	130	130	

Perform the following Steps while in the Song Write screen.

[Step 1] Before writing the rhythm pattern which will have the Tempo Change, use **SELECT** to choose "TMP".

```
SONG0 < WRITE >
PART 030 TMP 00?
```

↑
Value

[Step 2] Using **-1/OFF**, **+1/ON**, set the amount of Tempo Change (-99 - +99).
The setting is made in terms of how much change relative to a base tempo, the tempo before any changes are made, is to be applied. Negative values slow the tempo; positive ones quicken it. The amount of change set is added to the tempo before the Tempo Change.

[Step 3] Press **ENTER**.
The Tempo Change Part is written.

* Tempo Change settings beyond the allowable range (40 - 250) are ignored.

c. Level Change

During the course of song play, changes can be made in the level it is to be played at (overall level).

After setting a Level Change as a Part in a song, the level of play will change starting from the next Part with a rhythm pattern.

Song Data	Rhythm Pattern A	Rhythm Pattern B	Level Change - 8	Rhythm Pattern C	Rhythm Pattern D
Song Playing	Rhythm Pattern A	Rhythm Pattern B	Rhythm Pattern C	Rhythm Pattern D	
Level	32	32	24	24	

Perform the following Steps from the Song Write screen.

- [Step 1] Before writing the rhythm pattern which will have the Level Change, use **SELECT** to choose "LVL".

```
SONG0 < WRITE >
PART 030 LVL 00?
```

↑
Value

- [Step 2] Set the amount of change in level (-32 - +32) using **-1/OFF**, **+1/ON**.
The setting is made in terms of how much change is to be made relative to the level prevailing before any changes. Negative values decrease the level; positive ones increase it. The amount of change set is added to the level before the Level Change.

- [Step 3] Press **ENTER**.
The Part for Level Change is written to the song.

- * The level at which the song is to start is set by means of Initial Level. (see p. 79)
- * Settings for Level Change that exceed the maximum of 32 produce no further increase in level.

d. Label

Labels (of up to 4 characters) can be placed anywhere in a song. By placing reminders in the form of Labels at important points in a song, the song's composition becomes easier to grasp, allowing for more efficient editing afterwards. In addition, in cases where a Part number has shifted as a result of insertion or deletion of Parts, the Search Label function can allow you to quickly find the Part you need.

When playing a song as well, play can be started from a specified Label.

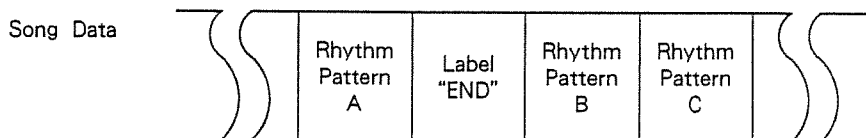

● Setting a Label

Perform the following Steps from the Song Write screen.

[Step 1] While at the Part where a Label is to be made, press **SELECT** to choose “_”.

```
SONG0 < WRITE >
PART 030 "_ "?
```

[Step 2] Using **-1/OFF**, **+1/ON** to move the cursor, input the name for the label using the VALUE slider and/or Numerical Keys.

Each press of a Numeric Key revolves you through selection of numerals/letters/symbols (the characters and symbols appearing above the keys). A small letters can be obtained by holding down **SHIFT** when pressing the Numerical Key.

[Step 3] Press **ENTER**.

The Label is written as a Part.

● Search Label

This function allows you to move rapidly to a position where a Label has been set. When there are numerous Labels, the search starts from the top of the song until it finds, and moves to the Label at the Part you want.

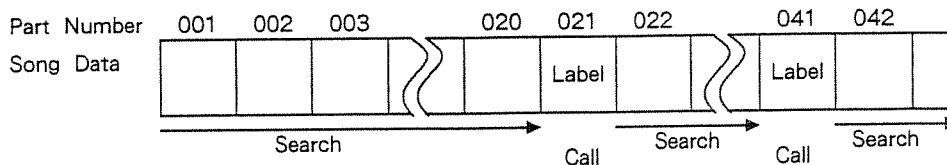

* For information on the Search Label function when it is used in Song Play screen, see page 78.

Perform the following while stopped, in Song Write.

[Step 1] While holding down **SHIFT**, press Pad Key **3**.

Search for Labels begins, starting at the song beginning. When the first label is found, the following appears:

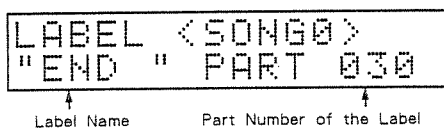

* When no Label is found, "No label" is displayed.

[Step 2] To search for the next Label, press **+1/ON**. To move back one Label, press **-1/OFF**.

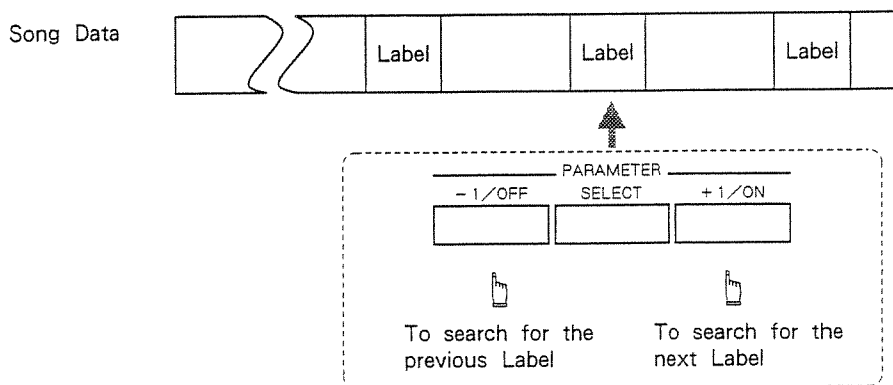

[Step 3] When you find the desired Label, press **ENTER** to select the Song Write screen.

2. Playing a Song

1. Song Play

The following provides play of the songs created in Song Write.

[Step 1] Press **SONG** to get the Song mode.

[Step 2] Press **1** in the Numerical Keys to specify "PLAY".

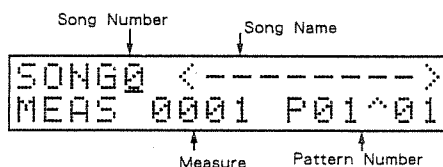

[Step 3] Select the number of the song (0 - 5) you wish to play using **-I/OFF**, **+I/ON**.

[Step 4] Press **START/STOP** to start play.

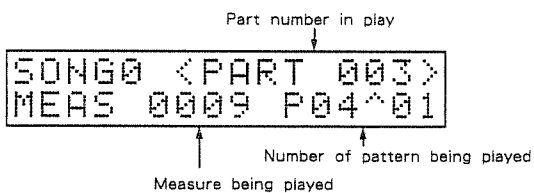





[Step 5] Press **START/STOP** and play will stop.

If you hold down **SHIFT** while pressing **START/STOP**, play starts again from where you last stopped.



a. Continue Play

Starts play from a specified measure.

Perform the following Steps while in Song Play and stopped:

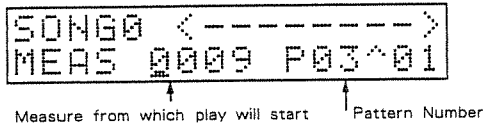
[Step 1] Use   to move the cursor to "MEAS", then specify the measure from which play is to start using , .



[Step 2] Hold down  while pressing , and play will start from the specified measure.

b. Start and Stopping Using a Pedal Switch

Through connection of a pedal switch to the START/STOP jack on the rear panel, the unit can be started or stopped with each press of the pedal.

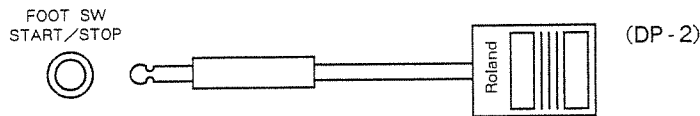

2. Song Chain

This function allows you to play several songs in succession.

Each song can accept setting for 1 song to be played after it. When a song number to be chained is set for each song, multiple songs can be played consecutively.

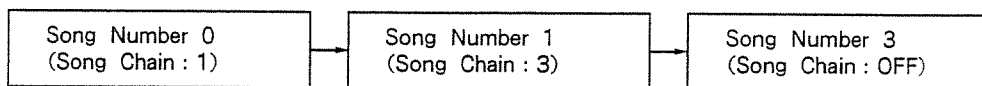

Perform the following, while stopped in Song Play.

[Step 1] Select the number of the song for which Song Chain is to be set.

[Step 2] While holding down **SHIFT**, press Pad Key **1**.

```

SONG CHAIN
SONG00 # OFF
      ↑
    Value
  
```

[Step 3] Select the number of the song (0 - 5) to be chained using **-1/OFF**, **+1/ON**.
When the song is not to be chained, the setting should be at "OFF". When you want to repeat play of the same song, specify the same song number.

[Step 4] Press **ENTER** to return to the original screen.

3. Search Label

Searches for any Labels you have previously set in a song.
Starts play from the rhythm pattern coming after the Label searched for.

* For setting Labels, see page 73.

Perform the following, while stopped in Song Play.

[Step 1] While holding down **SHIFT**, press Pad Key **3**.

The search for Labels begins, starting at the top of the song. When the first Label is found, the following is displayed:

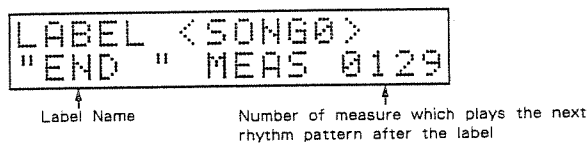

* When no Label is found, "No label" is displayed.

[Step 2] To search for the next Label, press **+1/ON**. To move back one Label, press **-1/OFF**.

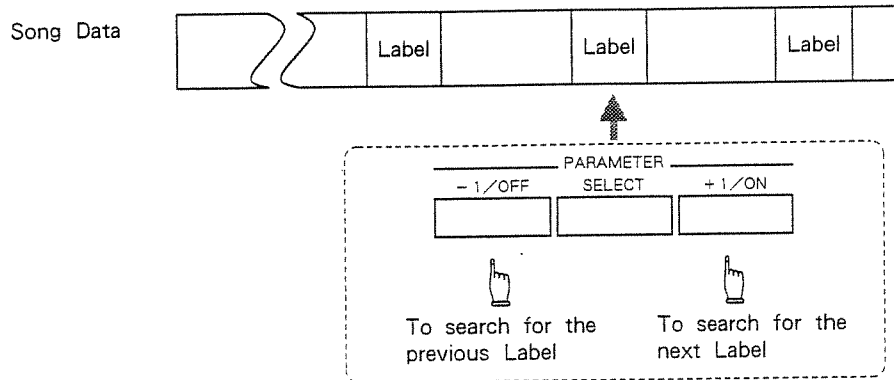

[Step 3] When you find the desired Label, press **ENTER** to select the Song Play screen.

[Step 4] Hold down **SHIFT** while pressing **START/STOP**, and play will start from the specified Label.

4. Initial Tempo and Initial Level

For each song, you can set the tempo (Initial Tempo) and level (Initial Level) that will prevail when play starts.

The Initial Tempo and Initial Level are automatically set when the song is started.

Perform the following Steps while in Song Play and stopped:

[Step 1] Select the number of the song for which the Initial Tempo or Level is to be set.

[Step 2] While holding down **SHIFT**, press Pad Key **2**.

```

INIT PAR <SONG0>
$TMP=*ON*  #=120
  
```

↑ Initial Tempo
↑ ON/OFF
↑ Value

[Step 3] Set Initial Tempo ON/OFF using **-1/OFF**, **+1/ON**.

ON: The Initial Tempo is set when the song is started.

OFF: An Initial Tempo is not set.

[Step 4] Use **▶** to move the cursor to the right, then set the Initial Tempo (40 - 250) using **-1/OFF**, **+1/ON**.

[Step 5] Pressing **SELECT**, choose "LVL".

```

INIT PAR <SONG0>
$LVL= 32
  
```

↑ Initial Level
↑ Value

[Step 6] Set the Initial Level (0 - 32) using **-1/OFF**, **+1/ON**. (At 0 no sound is produced)

[Step 7] Press **ENTER** to return to the original screen.

3. Song Editing

A wealth of functions that enhance the efficiency of Song Writing are available.

1. Part Delete

The specified range of Parts is deleted.

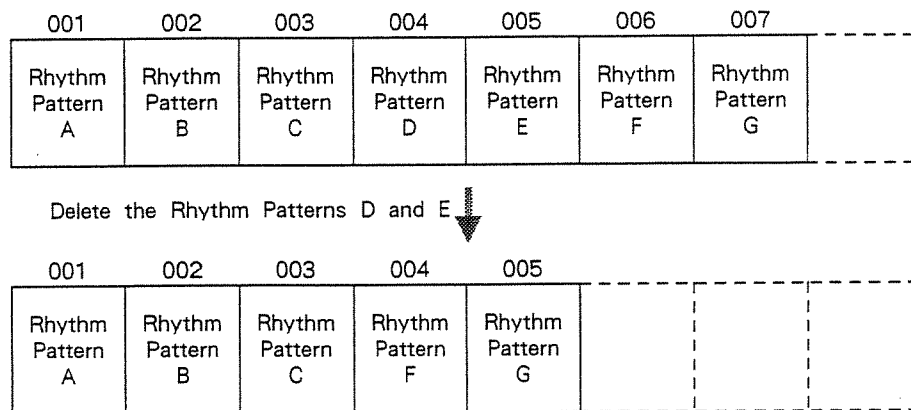

Perform the following Steps while in Song Write and stopped:

[Step 1] Select the first Part that is to be deleted using ◀ ▶.

[Step 2] While holding down **SHIFT**, press Pad Key **5**.

```

PART DEL <SONG0>
FROM 004 FOR 01
  
```

↑ Number of first Part being deleted ↑ Number of Parts to be deleted

* When there is no part to be deleted, "No part" is displayed.

[Step 3] Determine the number (01 to 99) of Parts to be deleted, using **-1/OFF**, **+1/ON**.

* You cannot specify more Parts than actually exist in the song.

[Step 4] Press **ENTER**.

"Completed" is displayed, and deletion is completed.

* To cancel the process, press **EXIT**.

2. Part Insert

Allows a new Part to be inserted partway through a song.

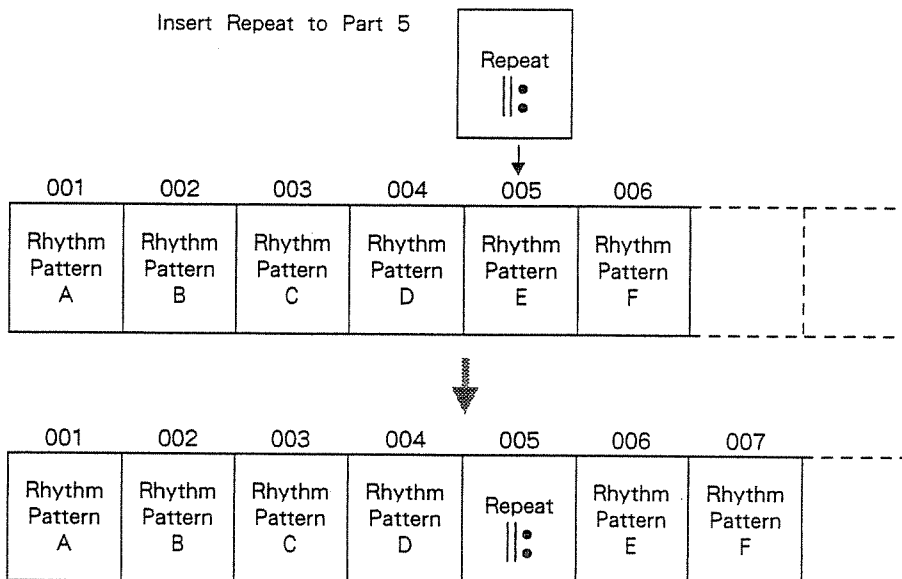

Perform the following Steps while in Song Write and stopped:

[Step 1] Select the number of the Part where insertion will take place using ◀ ▶.

* Insertion takes place immediately before the Part selected.

[Step 2] While holding down SHIFT, press Pad Key 6.

```
PART INS <SONG0>
PART 010 P15-02?
```

↑
↑

 Part number that is destination for insert Song Data to be inserted

[Step 3] Determine the Part to be inserted.

● To insert rhythm patterns

Specify the Pattern Number using -1/OFF, +1/ON.

● To insert Repeats/Tempo Changes/Level Changes/Labels

Use SELECT to choose the data, then set it.

* For details of setting each data type, see Repeat (p. 70), Tempo Change (p. 71), Level Change (p. 72), Label (p. 73).

[Step 4] Press ENTER.

The insertion is performed and "Completed" is displayed.

* To cancel the operation press EXIT.

3. Part Copy

A specified range of Parts are copied to other Part numbers.
 Convenient when creating songs using many repetitions of the same patterns.

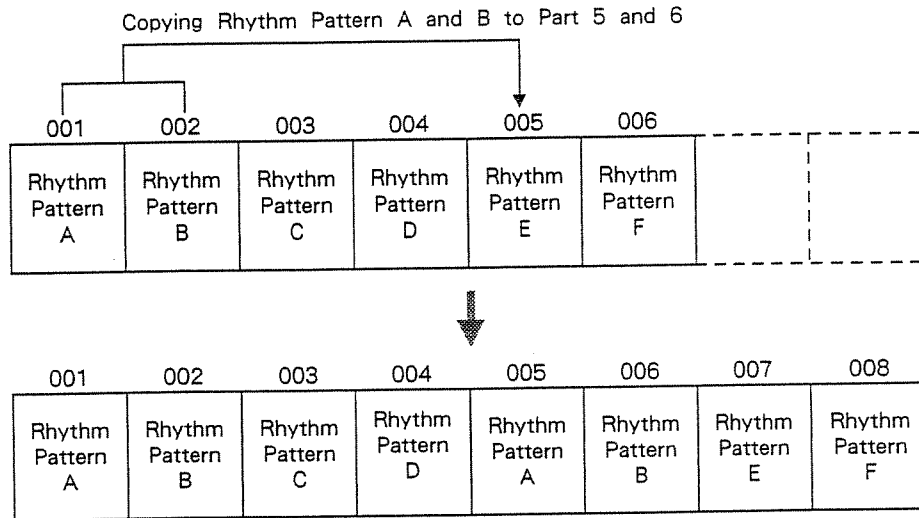

* Part Copy cannot be used between different songs.

Perform the following Steps while in Song Write and stopped:

[Step 1] Use to select the number of the copy-destination Part.

[Step 2] While holding down **SHIFT**, press Pad Key **7**.

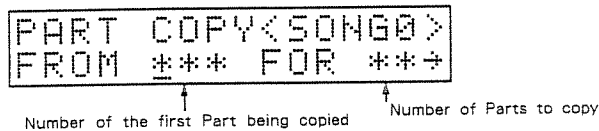

[Step 3] Using to move the cursor, specify the number of the Part where copy will start, and the number of Parts to copy (1 - 99), using **-1/OFF**, **+1/ON**.

[Step 4] Press **PAGE** to change to the screen used to set the number of times to copy.



[Step 5] Specify the number (1 to 9) of times to copy using **-1/OFF**, **+1/ON**.

[Step 6] Press **ENTER**.
The copy is performed and “Completed” is displayed.

- * To cancel the operation press **EXIT**.
- * When you have specified a destination lying within the range of Parts you have set, “Part Overlap” will be displayed, and you are returned to the screen in Step 2. Repeat Steps 3 through 6 and redo your settings.
- * When a specified Part does not exist, “No Part” is displayed.

4. Song Copy

Copies all the performance data in one song to another song number. Useful, for example, when wishing to retain a copy of a song in its original form before editing it.

Do as follows while in Song Play and stopped:

[Step 1] Select the number of the song to be copied.

[Step 2] While holding down **SHIFT**, press Pad Key **9**.

SONG COPY	
SONG0 >> SONG*	
↑	↑
Number of song to be copied	Copy-destination song number

[Step 3] Specify the copy-destination song number (0 - 5) using **-1/OFF**, **+1/ON**.

- * When you press **+1/ON** (or **-1/OFF**), the next higher (or lower) song number will appear in the display.
- * To cancel the procedure, press **EXIT**.

[Step 4] Press **ENTER**.
When there is no data in the destination song, the copy takes place, and “Completed” is displayed. When there is existing data at the destination song number, “Overwrite OK?” will be displayed. To continue and perform the copy, press **ENTER**. To cancel the operation, press **EXIT** instead.

5. Song Name

Every song created can be given a name using up to 8 characters. Since the Song Name is displayed in the Song Play screen, it can be used for easy recognition of your songs.

Follow these Steps while in Song Play and stopped:

[Step 1] Select the number of the song to be named.

[Step 2] While holding down **SHIFT**, press Pad Key **4**.

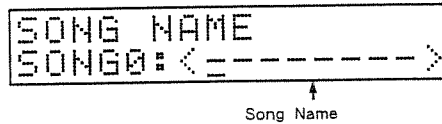

[Step 3] Moving the cursor with **◀ ▶**, use **-1/OFF**, **+1/ON**, the Numerical Keys, and the VALUE slider to enter the name.

Each press of a Numeric Key revolves you through selection of numerals/letters/symbols (the characters and symbols appearing above the keys). A small letters can be obtained by holding down **SHIFT** when pressing the Numerical Key.

[Step 4] Press **ENTER** to return to the original screen.

6. Song Clear

Erases (Clears) all performance data contained in a song. When first creating a new song, this allows you to erase all unneeded data.

Follow these Steps while in Song Play and stopped:

[Step 1] Select the number of the song to be cleared.

[Step 2] While holding down **SHIFT**, press Pad Key **10**.

```
SONG CLR <SONG#>  
Are you sure ?
```

[Step 3] Press **ENTER**.

The Clear is performed, and "Completed" is displayed.

* To cancel the procedure press **EXIT**.

Setting for Instruments

1	<i>Instrument Assignment</i>	<i>P.88</i>
2	<i>Editing Sounds</i>	<i>P.91</i>
3	<i>Adjusting Instrument Level</i>	<i>P.106</i>

1. Instrument Assignment

Any of the 68 instruments, or 26 Copy instruments can be assigned in any way you wish to the Pad Keys.

Each set of 16 instruments assigned to the 16 Pad Keys is called a **Pad Bank**. There are 5 Pad Banks (A to E) which you can use for selection.

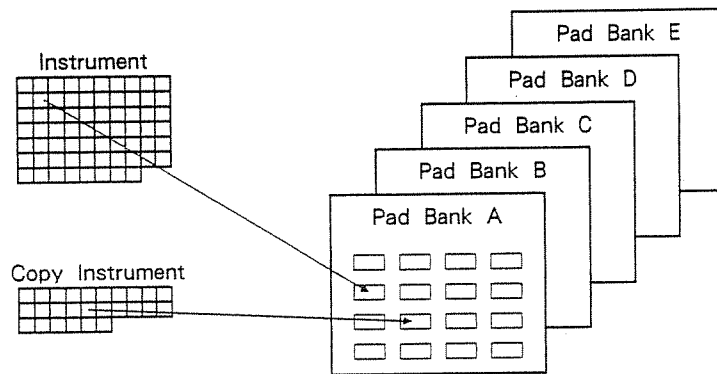

- * For a listing of the R-5's internal instruments, and the factory default Copy instruments, see p. 185 and p. 187.
- * Even after you have made changes in the Instrument Assignments, they can be returned to their original factory defaults (see p. 189) by carrying out initialization. (p. 127)

[Step 1] Press **INST ASSIGN** to get the Instrument Assignment mode.

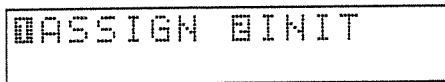

[Step 2] Press **1** in the Numerical Keys to specify "ASSIGN".

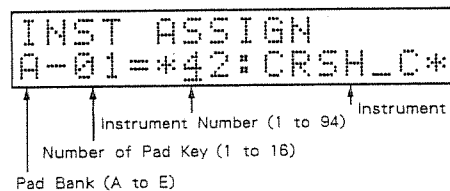

* When the Pad Banks are set to Multi Assign, the display will be as shown below. In this case, press **MULTI** to select Instrument Assign.

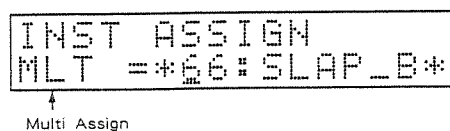

[Step 3] By pressing **PAD BANK**, select the Pad Bank for which the assignment is to be changed (A - E).

[Step 4] Press the Pad Key for which assignment is to be changed.

[Step 5] Select an instrument using **-1/OFF**, **+1/ON**.

* Use the Numerical Keys, when you want to enter the number of the Instrument directly.

* The same instrument can be assigned to more than one Pad Key.

* REST (Instrument #68) contains no data, and thus will not produce sound if assigned to a Pad Key. For usage of REST, see page 166.

[Step 6] When needed, repeat Steps 4 through 5.

[Step 7] To make settings for another Bank, repeat Steps 3 to 6.

[Step 8] Press **EXIT** to return to the Menu screen.

Changing Pad Banks

Each press of **PAD BANK** revolves you through selection of Pad Banks A through E.

The Condition function can be used to check the current Pad Bank.

[Step 1] Press **CONDITION**.

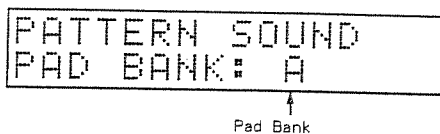

```

PATTERN SOUND
PAD BANK: A
  
```

↑
Pad Bank

In this screen as well **PAD BANK** can be pressed to change pad banks.

[Step 2] Press **CONDITION** once again to return to the original screen.

* For explanation of the Condition function, refer to p. 122.

● Multi Assign

This function assigns the same instrument to all of the Pad Keys.

On the R-5, in addition to the 5 ordinary Pad Banks (A - E), there is another Pad Bank (M) used for Multi Assign. The instrument set for this Pad Bank is assigned to all 16 Pad Keys. In addition, for the 16 Pad Keys, the Align function (see p. 104), which sets the values of the Performance Parameters (see p. 92) to a fixed values, can be used as well.

[Step 1] Press **INST ASSIGN** to select the Instrument Assignment mode.

[Step 2] Press **I** in the Numerical Keys to specify "ASSIGN".

[Step 3] Press **MULTI** to choose the Multi Assign screen.

```

INST ASSIGN
MLT =*65:FING_B*
  
```

↑
Instrument assigned to the Pad Bank for Multi Assign

[Step 4] Select the instrument using **-1/OFF**, **+1/ON**.

* The instrument number can be entered directly using the Numerical Keys.

[Step 5] Press **EXIT** to return to the Menu screen.

Play using Multi Assign To use Multi Assign while playing, press **MULTI**.

With each press of **MULTI** you can select in revolving order either the ordinary Pad Banks (A - E) or the Multi Assign Pad Bank (M).

* While in Multi Assign, Pad Bank change cannot be carried out.

2. Editing Sounds

The sound of each instrument can be edited to suit the type of music or your personal preferences.

The same instrument can be made to perform many varied roles as a result of editing it.

1. Parameters Affecting the Sound

The parameters available for editing the sounds of the instruments are the Sound Parameters, Performance Parameters, and Sequence Parameters. These parameters are inter-related as follows:

■ Data Flow of each Parameters

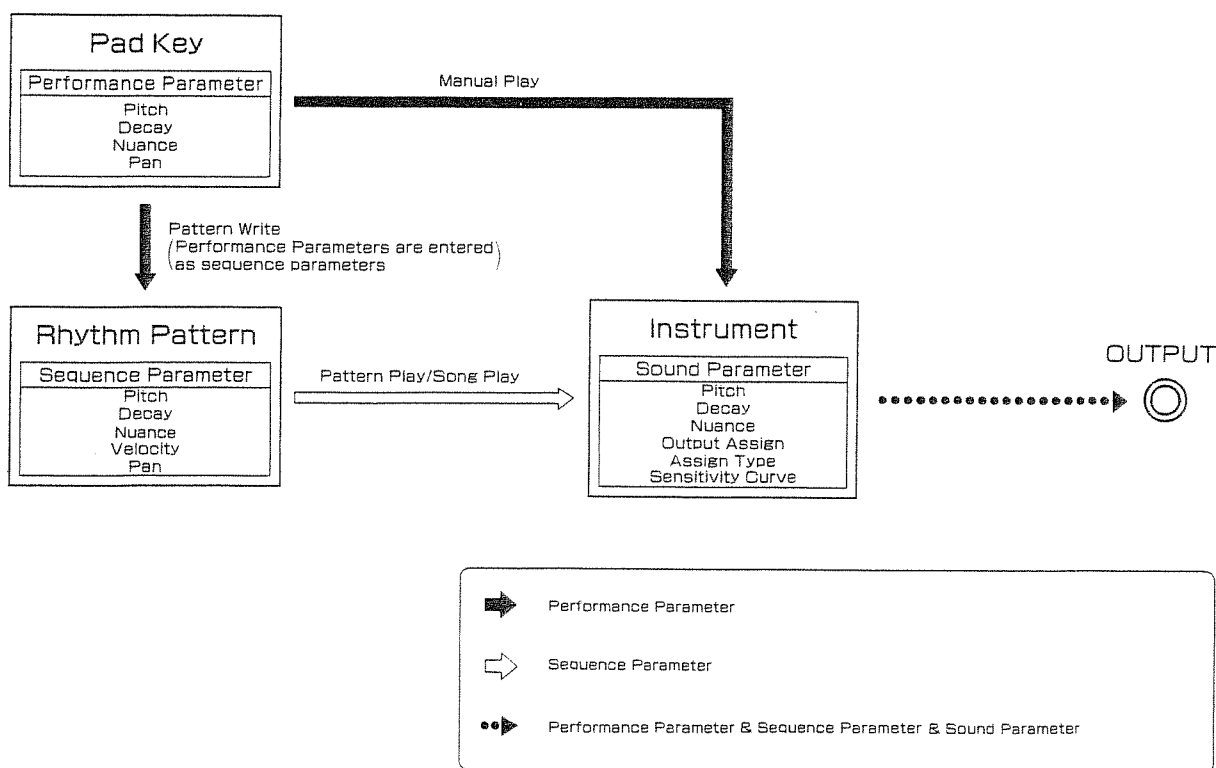

Try to first get a good grasp of how each of the parameters function, then edit them to suit your purpose.

[Sound Parameters]

The basic sound of the instrument is determined by these parameters. When the Performance and Sequence Parameters are to be set, the values of the Sound Parameters form their basis.

Usage

- Before performing Pattern Write, the basic sound the song is to have is set in the Sound Parameters.
- After creation of a song, should you want to change the sound of an instrument in all cases where it occurs in any pattern, the sound parameters are edited.

[Performance Parameters]

These parameters determine the sound produced by the Pad Keys. They are based on the values in the Sound Parameters, and you set the amount of additional change, relative to each Pad Key. The sound produced when you tap a Pad Key is thus a combination of the Sound and Performance Parameters. The values for Performance Parameters that are set to the Pad Keys in Pattern Write are input to the rhythm pattern as Sequence Parameters.

Usage

- If you assign the same instrument to multiple Pad Keys, and then change the Performance parameters for each Pad Key, one instrument can be played at a variety of timbres.

Functions that are available are the Multi Assign function (p. 90), for assigning the same instrument to the 16 Pad Keys; and the Align function (p. 104), for changing at a fixed interval the Performance Parameters of the 16 Pad Keys.

- If you change the Performance Parameters before writing a pattern, a single instrument can be used at a variety of timbres, depending on the rhythm pattern.

* The settings for the Performance Parameters change only the sound produced when a Pad Key is played manually. They have no effect on the sound during rhythm pattern or song play.

[Sequence Parameters]

Accept settings affecting the sound of individual notes input in a rhythm pattern.

For those parameters other than Velocity, the values for the Sound Parameters form the foundation. When a rhythm pattern is played, the sound is produced in accord with the values of the Sound Parameters plus the Sequence Parameters.

Usage

- Used for altering the Velocity of sounds in a rhythm pattern; or for having a single instrument in a rhythm pattern play at various timbres.

For the methods used in editing the Sequence Parameters, see p. 58.

2. Sound Parameters

a. How the Parameters Work

- Pitch
(-4800 - +4800 cents)

```
SND EDIT(DRY_K1)
$PITCH = 0000
```

The pitch of an instrument can be set in 10-cent units. (a semitone=100 cents)
Higher values increase the pitch.

* Some instruments, after surpassing a certain value, no longer change in pitch.

- Decay (000 - 127)

```
SND EDIT(DRY_K1)
$DECAY = 004:019
```

Here the instrument's decay time is set. As the value is increased, the decay time is lengthened.

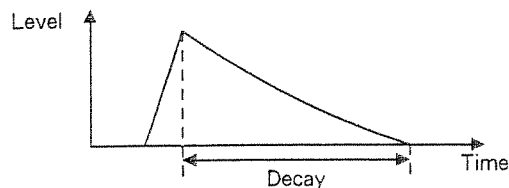

With instruments accepting settings for Nuance, 2 Decays can be set. In these cases, two values will appear in the display.

Use to move the cursor to the Decay you wish to set.

● In the chart on page 185, the kick, snare, and tom instruments indicated with an "*" take two Decay settings. One is for the attack portion (higher frequency content; value at left), and the other for the body (lower frequency content; value at right). With snare, the effect obtained is similar to tightening the snare; and with the tom it has a muting effect.

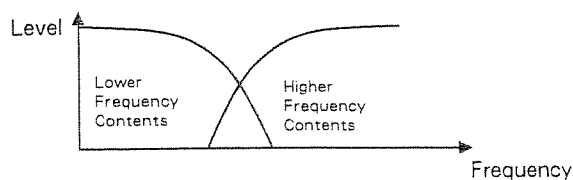

● In the chart on page 185, instruments indicated with “ * * ”, such as hi-hat or ride cymbal, can take settings for Decay representing the sound content when hitting near the cymbal’s cup (value at right) or at the edge (value at left). Through your settings for the two Decays, you can make subtle changes in the effect.

Sound when played near cup

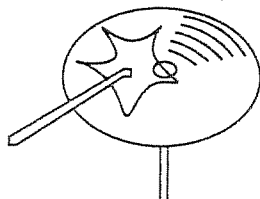

Sound when played near edge

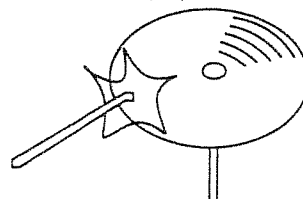

* With some instruments, after a certain value has been surpassed, no further change in decay is afforded. Also, Decay will not change for reversed type instruments. (instrument numbers 63, 64).

Nuance (0 - 15)

```
SND EDIT(DRY_K1)
$NUANCE = 14
```

Through settings for Nuance, the timbre can be subtly changed for instruments indicated by “ * ” or “ * * ” in the chart on page 185.

● With instruments indicated with “*” there will be an increase in the lower frequency content when the value is increased.

● With instruments indicated with “ * * ”, when the value is increased the sound will be as if the cymbal was hit closer to the cup.

* When the instrument does not accept settings for Nuance, “ – – ” will be displayed at the value.

Output Assignment
(LEFT 1 - 3, CENTER,
RIGHT 1 - 3, MULTI 1 - 4)

```
SND EDIT<DRY_K1>
$OUTPUT=*CENTER*
```

You can select the jack from which any instrument will be output. (Stereo Out/Multi Out 1 - 4).

When using Stereo Output, pan (orientation of sound imaging) can be set from among 7 positions.

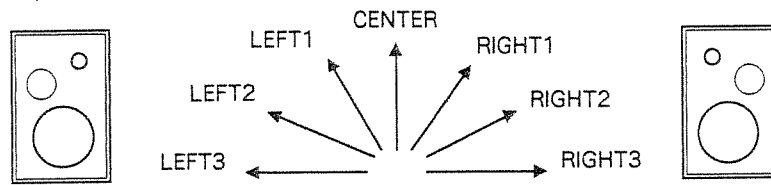

Also, through outputting sounds from Multi Out, effects or other devices can be applied to particular instruments.

Assign Type
(POLY/MONO/EXC 1 - 8)

```
SND EDIT<DRY_K1>
$ASSIGN=*POLY*
```

Here settings are made to determine the way sounds will be produced when one or more instruments are played continuously.

● **POLY**

When one instrument is to be played continuously, previously playing sounds are retained while newer sounds play. With instruments having a long decay, such as a cymbal, POLY is an effective setting.

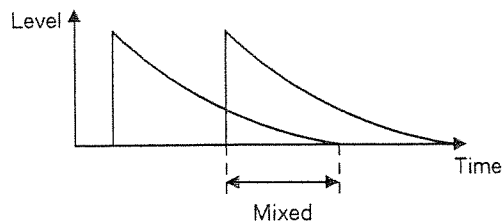

● MONO

When the same instrument is played continuously, previous sounds are cancelled, allowing newest sounds to be produced.

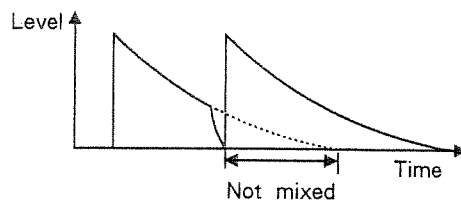

● EXC 1 - 8

Any instruments having the same EXC number cannot be sounded together. This allows instruments that would not normally be sounded together, such as open and closed hi-hat, to not be sounded together as a result of setting them at the same EXC number.

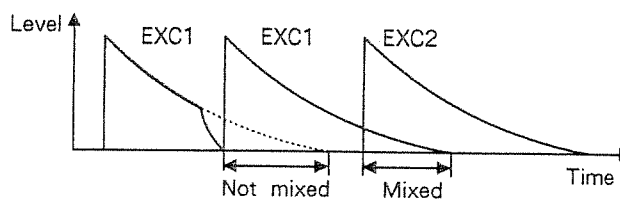

Sensitivity Curve (1 to 8)

```
SND EDIT(DRY_K1)
$CURVE = 2
```

Any of the following 8 types of curves can be chosen for controlling the way volume is changed depending on the strength the Pad Keys are hit.

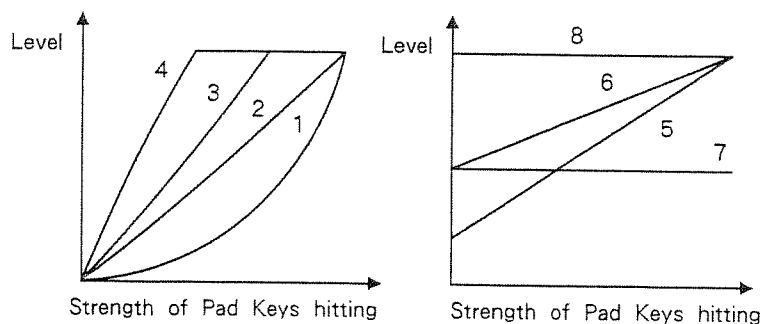

b. Editing

Editing refers to the making of settings for the Sound Parameters.

Up to 26 instruments which have had their parameters edited can be stored as "Copy" instruments. (see p. 100)

- * Once the Sound Parameters have been changed, the sounds contained in all rhythm patterns will be simultaneously changed. Should you wish to retain all settings in rhythm patterns contained in other songs, their data should be saved before editing is carried out. (see p. 130)
- * Even after changes have been made in the Sound Parameters, they can always be changed back to their factory defaults (see p.191) by performing initialization (see p.125).

[Step 1] Press **SOUND** to get to the Sound Edit mode.

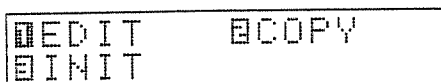

[Step 2] Press Numeric Key **1** to specify "EDIT".

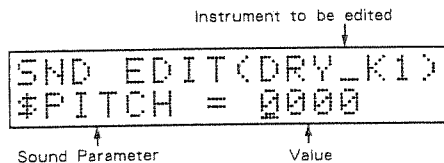

[Step 3] Tap the Pad Key for the instrument you wish to edit.

When necessary, change Pad Banks using **PAD BANK**.

- * If you hold down **SHIFT** while pressing **+1/ON** (or **-1/OFF**), you can select the next higher (or lower) numbered instrument.

Hold down **SHIFT** while pressing **SELECT** to listen to the selected instrument.

[Step 4] With **SELECT**, choose the parameter.

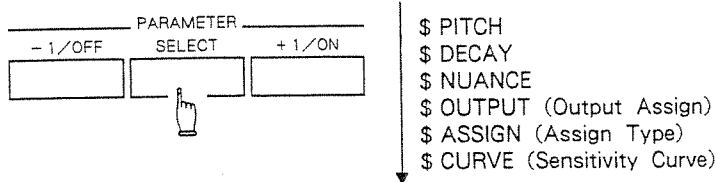

- [Step 5] **Change the value using -1/OFF, +1/ON.**
Check the actual sound by tapping the Pad Key when making the setting.
- [Step 6] **To edit other parameters, repeat Steps 4 to 5.**
- [Step 7] **To edit other instruments, repeat Steps 3 to 6.**
- [Step 8] **Press SOUND to return to the original screen.**

3. Copy Instruments

Up to 26 different Copy instruments, which are instruments that have been edited using the Sound Parameters, can be registered for use.

Once an instrument has been registered as a Copy instrument, it can be handled differently than the original. The sound of a Copy instrument can be edited any way you please using the Sound Parameters.

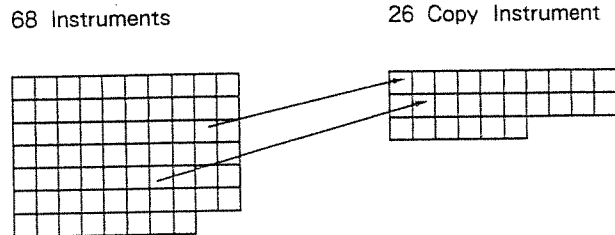

Perform the following to register a Copy instrument:

[Step 1] Press **SOUND** to get to the Sound Edit mode.

[Step 2] Press Numeric Key **2** to specify "COPY".

```
SOUND COPY
*CP01*=(DRY_K1)
```

↑ ↑
 Number of Copy Instrument Source Instrument

[Step 3] Select the number of the destination for the Copy instrument (COPY 01 - 26), using **-1/OFF**, **+1/ON**.

If you press **SELECT** at this time, you can listen to the sound of instruments currently registered.

[Step 4] Press the Pad Key for the instrument you wish to copy.

When necessary, change Pad Banks using **PAD BANK**.

* If you hold down **SHIFT** while pressing **+1/ON** (or **-1/OFF**), you can select the next higher (or lower) numbered instrument.

Hold down **SHIFT** while pressing **SELECT** to listen to the selected instrument.

```
SOUND COPY Sure?
*CP01*=(RIM_S1)
```

↑
 Specified Instrument

[Step 5] Press **ENTER**.

“Completed” is displayed, indicating the instrument has been registered.

* To cancel the procedure, press **EXIT**.

[Step 6] Press **EXIT** to return to the Menu screen.

4. Performance Parameters

a. How the Parameters Work

- Pitch**
(-4800 to +4800 cents)
- The pitch of an instrument can be set in 10-cent units. (a semitone=100 cents)
Higher values increase the Pitch.
- * At 0, the Pitch becomes that of the Sound Parameters.
- Decay (-63 to +63)**
- Here the instrument's decay time is set. As the value is increased, the decay time is lengthened.
With instruments accepting settings for Nuance, the value is added to each Decay. (see p. 94)
- * At 0, the Decay takes on the value of the Sound Parameters.
- Nuance (-7 to +7)**
- Through setting Nuance, the timbre can be subtly changed. (see p. 95)
- * With instruments not accepting settings for Nuance, no change in tone color can be obtained even if the value is changed.
* At 0, the Nuance becomes that of the Sound Parameters.
- Pan**
(L1 - 3/ C/ R1 - 3/ OFF)
- For instruments which have their Output Assignment in the Sound Parameters set to Stereo Output (LEFT 1 - 3, CENTER, RIGHT 1 - 3), settings for Pan (orientation of sound image) can be changed.
- * With Pan, the settings in the Performance Parameters have priority. At OFF the orientation becomes that of the Sound Parameters.
* For instruments assigned Multi Output as the Output Assignment in the Sound Parameters, no change in orientation is obtained even when Pan is changed.

b. Editing

Editing here refers to the changes in settings made in the Performance Parameters of the Pad Keys.

* The timbre of an instrument can be changed within the limits defined by the Sound Parameters. Thus, when the values of the Performance Parameters, after being added to the Sound Parameters, exceed the permissible range, no further change is obtained.

[Step 1] Press **PERFORM** to get to the Performance Edit mode.

```

EDIT  BALIGN
CLEAR
    
```

[Step 2] Press Numeric Key **1** to specify "EDIT".

```

          Pad Bank
          |
          v
PFM EDIT <A-01>
$PITCH = 0000
          |
          v
Performance Parameter      Value
    
```

[Step 3] Press the Pad Key for the instrument you wish to edit.
When necessary, press **PAD BANK** to change Pad Banks.

[Step 4] With **SELECT**, choose the parameter.

```

PARAMETER
- 1/OFF  SELECT  + 1/ON
[ ] [ ] [ ]
          |
          v
$ PITCH
$ DECAY
$ NUANCE
$ PAN
    
```

[Step 5] Change the value using **-1/OFF**, **+1/ON**.
Check the actual sound by tapping the Pad Key when making the setting.

[Step 6] To edit other parameters, repeat Steps 4 and 5.

[Step 7] To edit other instruments, repeat Steps 3 to 6.

[Step 8] Press **PERFORM** to return to the original screen.

c. Align

This function sets the values for the Performance Parameters of the 16 Pad Keys (1 - 16) (Pitch/ Decay/ Nuance only) to fixed intervals in order as follows:

Pitch				Decay				Nuance			
-800	-700	-600	-500	-36	-33	-30	-27	-7	-7	-6	-5
-400	-300	-200	-100	-24	-21	-18	-15	-4	-3	-2	-1
0	+100	+200	+300	-12	-9	-6	-3	0	+1	+2	+3
+400	+500	+600	+700	0	+3	+6	+9	+4	+5	+6	+7

When used in combination with the Multi Assign function, which assigns the same instrument to all of the Pad Keys, you can do things such as play the hi-hat with varying, separate changes in decay, or play the scale with the bass, with the Pitch of each Pad Key at a half-Step from each other (see p.90).

[Step 1] Press **PERFORM** to get to the Performance Edit mode.

[Step 2] Press Numeric Key **2** to specify "ALIGN".

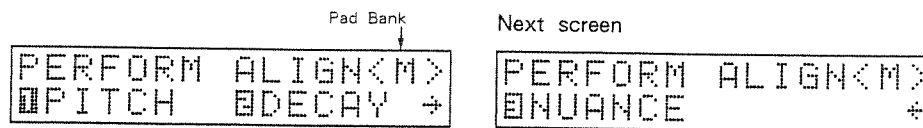

[Step 3] Select the Pad Bank for which Align is to be set.

Pad Banks A to E are selected using **PAD BANK**.

To select the Multi Assign Pad Bank (M), press **MULTI**.

With further presses of **MULTI**, you can select alternately between the ordinary Pad Banks and the Multi-Assign Pad Bank.

* When the Multi-Assign Pad Bank is selected, you cannot change among Pad Banks A through E.

[Step 4] Using Numerical Keys **1** through **3**, select the Performance Parameter that is to be set with the Align function.

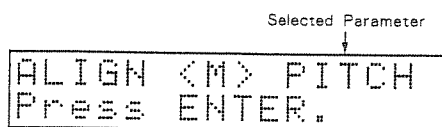

[Step 5] Press **ENTER**.
"Are you sure?" will be displayed.

* To cancel the setting for Align, press **EXIT**.

[Step 6] Press **ENTER** again.
"Completed" is displayed, indicating the alignment has been made.

* When the values of the Performance Parameters, added to the values of the Sound Parameters for any Pad Keys exceed the allowable range for the Sound Parameters, the values are set so they fall within the range.

3. Adjusting Instrument Level

To adjust the level of each Instrument, do as follows.

[Step 1] Press **LEVEL**.

```
LEVEL ADJUST
(DRY_K1)= 15
```

↑ ↑
Instrument Value

[Step 2] Press the Pad Key for the instrument for which you want to change the level. If necessary, use **PAD BANK** to change Banks.

* If you hold down **SHIFT** while pressing **+1/ON** (or **-1/OFF**), you can select the next higher (or lower) numbered instrument. Also, if you hold down **SHIFT** and press **SELECT**, you can hear the selected instrument.

[Step 3] Set the level (0 - 15) using **-1/OFF**, **+1/ON**.

The higher the value, the higher the level of sound volume. (At 0 no sound will be produced.)

[Step 4] To make settings for other instruments, repeat Steps 2 and 3.

[Step 5] Press **LEVEL** to return to the original screen.

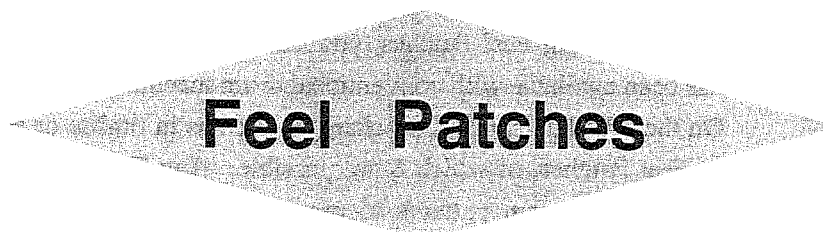

Feel Patches

1	<i>Feel Patches</i>	<i>P.108</i>
2	<i>How the Parameters Work</i>	<i>P.110</i>
3	<i>Setting Parameters</i>	<i>P.113</i>

1. Feel Patches

Through use of Feel Patches, a level of expression much closer to that of a live drummer can be achieved. When a real drummer performs, they may emphasize certain beats, or vary slightly the strength and position of each hit. For this reason, the sound of each hit will vary in timbre.

Thus, by using Feel Patches, you can express changes in sound beyond what has been available with conventional drum machines.

On the R-5 data concerning changes, such as in timbre or accent, can be stored as Feel Patches, of which 8 are possible. Any Feel Patch created can then be applied to rhythm patterns to provide performances having more expressive capabilities.

Makeup of a Feel Patch

Contained in a Feel Patch are the elements of *Groove* and *Random Factor*.

Through the combination of these elements, changes can be made in the Sequence Parameters (Velocity/Pitch/Decay/Nuance only) respective to each note in a rhythm pattern, thus creating the added expression.

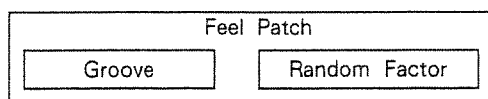

● Groove

The regular variations in strength in the accents, including changes in timbre, are patternized, and then used to periodically change the sound in rhythm patterns.

Groove sets a relative value for the Sequence Parameters respective to groups of identical notes (4 for eighth notes; 8 for sixteenth notes, etc.) such as below.

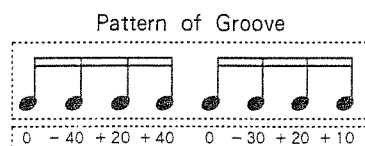

Relative values for Sequence Parameters

When a Feel Patch is assigned to a rhythm pattern, a relative value is added to sounds (Sequence parameters for the specified instrument) having the same timing as the timing set for Groove.

〈Ex.1〉

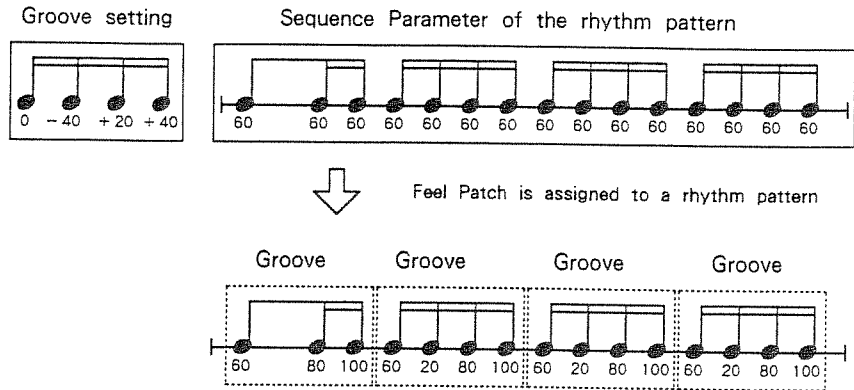

〈Ex.2〉

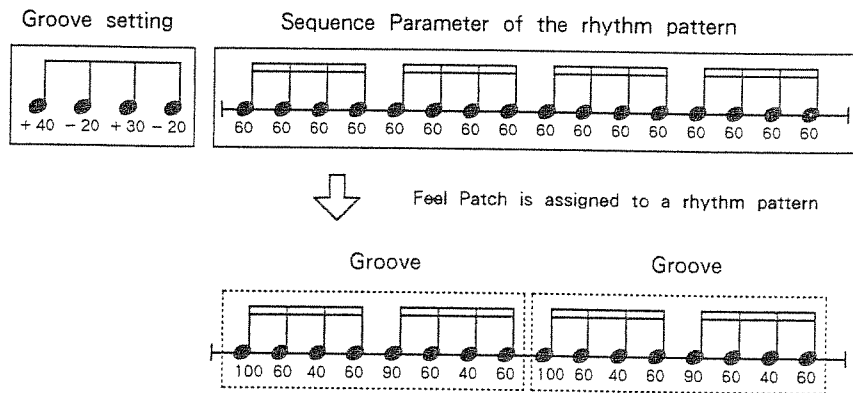

Since the relative value set for Groove will be repeatedly added within one rhythm pattern, periodic changes in timbre are obtained.

●Random Factor

Provides for random changes in the sounds in a rhythm pattern.

Subtle variations in timbre, such as produced by changing hitting strength or position, can be expressed through setting the Random Factor. Thus, even if you play the same rhythm pattern, there will be differences in the sound each time.

2. How the Parameters Work

Feel Patches are set by means of the following parameters:

Parameter	Variable Range
Groove Select Groove Type Groove Step	1 - 8 1/4 - 1/32
Instrument Select	INST1 - 8
Groove Switch Random Factor Switch	ON/OFF ON/OFF
Groove	- 99 - + 99 (Nuance : - 7 - + 7)
Random Factor Probability Random Depth	1 - 8 1 - 4
Instrument Switch INST1~8	ON/OFF

1. Patch Parameters

Settings are made for the Groove's pattern, and the instrument to be changed by the Feel Patch.

a. Groove Select

With Groove Select, you select the timing of the sounds within a rhythm pattern that will be changed as a result of Groove.

Groove Select is set by means of Groove Type and Groove Step.

●Groove Type (1 to 8)

Set here is the number of times that sound will be changed in one cycle.

●Groove Step (1/4 to 1/32)

Here is set the interval at which sound will be changed.

<Ex.>

Groove Type : 4
Groove Step : 1/8

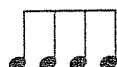

Groove Type : 8
Groove Step : 1/16



b. Instrument Select (INST 1 to 8)

Eight instruments for which the timbre can be changed with each Feel Patch can be selected. Instrument Select is common to both Groove and Random Factor.

2. *Feel Parameters*

The following parameters are set for each Sequence Parameters:

a. Groove Switch/ Random Factor Switch (ON/OFF)

Individual settings are made for whether (ON) or not (OFF) variation is to be applied to the Groove and Random Factor.

* When both Groove and Random Factor are set to OFF, no change is obtained when a Feel Patch is used.

b. Groove

With respect to every timing set for Groove Select, a relative value is set for the Sequence Parameters.

The values set for the sounds in a rhythm pattern (Sequence Parameters) that match the timing of Groove are added.

c. Random Factor

Applies random changes to the Sequence Parameters set respective to each sound in a rhythm pattern.

The Random Factor is set by means of the Probability and Random Depth.

●Probability (1 to 8)

Sets the proportion and extent of change applied to the Sequence Parameters.

The higher the value, the larger the proportion, and broader the extent of change to the Sequence Parameters becomes.

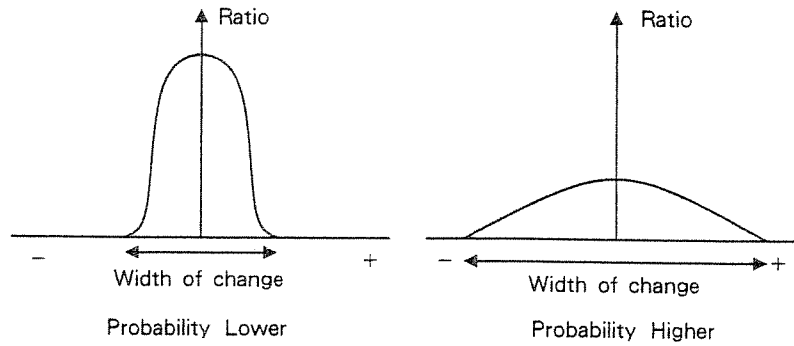

● **Random Depth (1 to 4)**

Sets the extent of change effected by Probability.

The higher the value, the broader the extent of the changes become.

d. Instrument Switches (ON/OFF)

Set, on an individual Sequence Parameter basis, the particular instruments that will have change applied to them. This is in respect to those instruments that have been selected with Instrument Select, and that will use a Feel Patch (Groove/ Random Factor).

3. Setting Parameters

After reading “1. Setting Patches”, you should continue, as required, and refer to “2. Setting Groove” and/or “3. Setting Random Factor”.

1. Setting Patches

[Step 1] Press **FEEL** to get to the Feel Edit mode.

```

┌───┐
│ PATCH  VELO │
│ PITCH  DECAF │
└───┘

```

[Step 2] Press Numerical Key **1** to specify “PATCH”.

```

┌───┐
│ FEEL PATCH │
│ PATCH= #0  │
└───┘

```

↑
Feel Patch Number

[Step 3] Select the number (0 to 7) of the Feel Patch to be set using **-1/OFF**, **+1/ON**.

[Step 4] Press **PAGE** to get to the Groove Select screen.

```

┌───┐
│ GROOVE <#0> │
│ TYPE=4 STEP=1/8 │
└───┘

```

↑ ↑
Groove Type Groove Step

[Step 5] Using **◀ ▶** to move the cursor, and then make settings for Groove Type (1 - 8) and Groove Step (1/4 to 1/32), using **-1/OFF**, **+1/ON**.

[Step 6] Press **PAGE** to get to the Instrument Select screen.

```

┌───┐
│ FEEL INST <#0> │
│ INST1=(DRY_K1) │
└───┘

```

↑
Instrument

[Step 7] At INST 1 -8 in the display, assign the instrument for which change is to be made using a Feel Patch.

Use **SELECT** to choose among INST 1 to 8, and specify the instrument using the Pad Keys. If necessary, use **PAD BANK** to change Pad Banks.

* If you hold down **SHIFT** while pressing **+1/ON** (or **-1/OFF**), you can select the next higher (or lower) numbered instrument. Hold down **SHIFT** while pressing **SELECT** to listen to the selected instrument.

[Step 8] Press **EXIT** to return to the Menu screen.

2. Setting Groove

After the Feel Patch set in “1. Setting Patches”(p.113) has been assigned to a rhythm pattern, settings for Groove are made.

Carry out the following from Pattern Play, with play stopped:

[Step 1] Select the rhythm pattern to which a Feel Patch is being assigned.

[Step 2] Use **◀ ▶** to position the cursor at “FEEL=”, then select the number (0 - 7) of the Patch set in “1. Setting Patches”.

[Step 3] Press **START/STOP** to start play.

[Step 4] Press **FEEL** to enter the Feel Edit mode.

[Step 5] Press **1** in the Numerical Keys to specify “PATCH”, then select the Feel Patch being set using **-1/OFF**, **+1/ON**.

Select the Feel Patch that has been assigned to the rhythm pattern currently playing.

[Step 6] Press **EXIT** to return to the Menu screen, then use Numerical Keys **2** to **5** to select the parameters involved in setting Groove.

2: VELO (Velocity)

3: PITCH

4: DECAY

5: NUANCE

[Step 7] Set the Groove Switch to ON/OFF using **-1/OFF**, **+1/ON**.

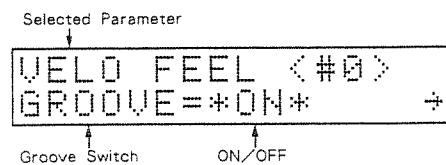

[Step 8] Press **PAGE** to get to the screen for setting Groove.

GRU(4) <VELO >
 000 000 000 00

Groove Type Parameter
 Timing Relative value

[Step 9] Use **◀▶** to position the cursor at the timing being set, then set the relative value for the specified timing using **-1/OFF**, **+1/ON**. (- 7 to +7 for Nuance and - 99 to +99 for other parameters.)

When the Groove Type has been set 5 or higher, press **▶** to move to the screen where setting is made for timings 5 to 8.

[Step 10] Press **PAGE** three times to get to the Instrument Switch screen.

INST SW<VELO >
 \$1: DRY_K1=*ON* +

Parameter
 Instrument selected with Instrument Select ON/OFF

[Step 11] Use **SELECT** to change among INST 1 - 8, and set Instrument Switches either ON or OFF. (common to Random Factor)

[Step 12] When other Sequence Parameters are to be set, after pressing **EXIT** to return to the Menu screen, repeat Steps 6 through 11.

[Step 13] Press **FEEL** to return to the original screen.

3. Setting Random Factor

After the Feel Patch set in “1. Setting Patches”(p.113) has been assigned to a rhythm pattern, settings for Random Factor are made.

Perform the following from Pattern Play, while stopped:

- [Step 1] Select the rhythm pattern for which a Feel Patch is assigned.
- [Step 2] Use **◀▶** to position the cursor at the value for “FEEL=”, then select the number of the Feel Patch (0 to 7) set in “1. Setting Patches.”
- [Step 3] Press **START/STOP** to start play.
- [Step 4] Press **FEEL** to get to the Feel Edit mode.
- [Step 5] Press **I** in the Numerical Keys to specify “PATCH”, and select the Feel Patch being set (0 to 7) using **-1/OFF**, **+1/ON**.

Select the Feel Patch assigned to the rhythm pattern currently being played.

- [Step 6] Press **EXIT** to return to the Menu screen, and select the parameters for which the Random Factor is to be set with Numerical Keys **2** to **5**.

- 2: VELO (Velocity)
- 3: PITCH
- 4: DECAY
- 5: NUANCE

- [Step 7] Press **PAGE** twice to get the screen for setting the Random Factor Switches.

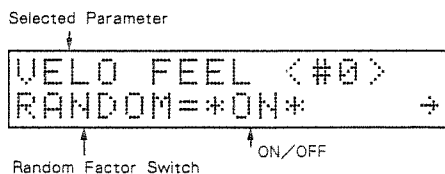

- [Step 8] Set the Random Factor Switches either ON or OFF using **-1/OFF**, **+1/ON**.
- [Step 9] Press **PAGE** to get the screen for setting the Random Factor.

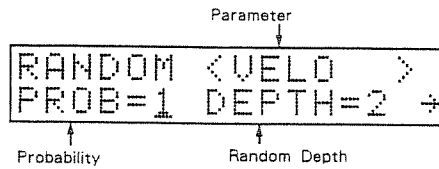

[Step 10] Use **◀** **▶** to move the cursor, and set the Probability (1 to 8) and Random Depth (1 to 4).

[Step 11] Press **PAGE** to get the Instrument Switch screen.

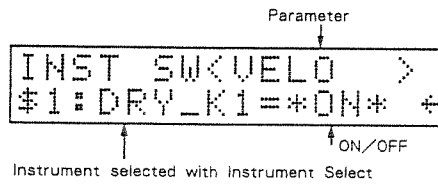

[Step 12] Switch among INST 1 - 8 using **SELECT**, and set the Instrument Switches using **-1/OFF**, **+1/ON** to either ON or OFF. (common with Groove)

[Step 13] When settings are to be made for other Sequence Parameters, press **EXIT** to return to the Menu screen, then repeat Steps 6 through 12.

[Step 14] Press **FEEL** to return to the original screen.

4. Assigning Feel Patches

After being set, the Feel Patch is assigned to a rhythm pattern (programmable pattern).

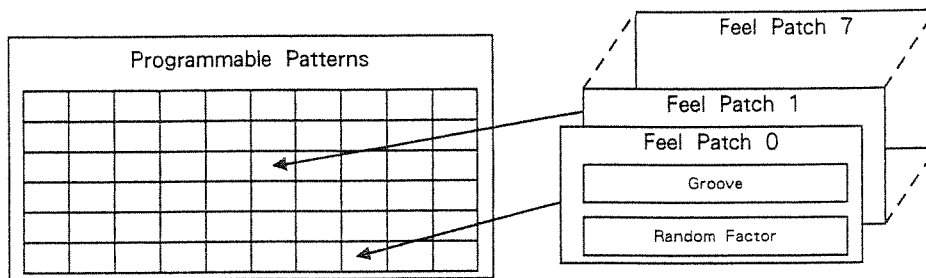

Even when using the same rhythm patterns, they will sound different in performance through application of Feel Patches. In addition, an identical range of expression can be obtained by applying one Feel Patch to a number of rhythm patterns.

Perform the following in Pattern Play mode with play stopped:

[Step 1] Select the rhythm pattern to which a Feel Patch is to be assigned.

[Step 2] Use to position the cursor to the value for "FEEL=", and select the number (0 to 7) of the Feel Patch you wish to assign using , .

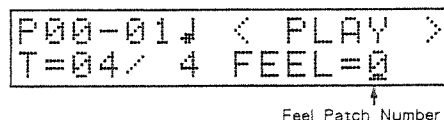

* Select " * " when no Feel Patch is to be assigned.

[Step 3] When the rhythm pattern is started, play will take place in accord with the settings made in the Feel Patch.

* The effect of the Feel Patch cannot be obtained in modes other than Pattern Play and Song Play.

5. Copying Feel Patches

The settings of one Feel Patch can be copied to another.

This is convenient for when numerous similar Feel Patches are to be made, since the copies can be revised in part to provide new Patches.

- [Step 1] Press **FEEL** to get the Feel Edit mode.
- [Step 2] Press Numeric Key **1** to specify "PATCH", and select the Patch (0 to 7) that you want to copy.
- [Step 3] Press **EXIT** to return to the Menu screen. Then press Numeric key **6** to specify "COPY".

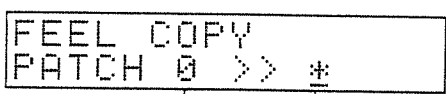

The screenshot shows a two-line menu: "FEEL COPY" on the top line and "PATCH 0 >> *" on the bottom line. The "0" is underlined. Below the "0", an upward-pointing arrow is labeled "Number of Patch to be copied". Below the "*", another upward-pointing arrow is labeled "Copy-destination Patch number".

- [Step 4] Select the number (0 to 7) of the Feel Patch that becomes the destination of the copy, using **-1/OFF**, **+1/ON**.

* When you press **+1/ON** (or **-1/OFF**), the next higher (or lower) numbered Feel Patch will appear in the display.

- [Step 5] Press **ENTER**.
"Completed" will appear, indicating the copy has been made.

* To cancel the operation, press **EXIT**.

Other Functions

1	<i>Condition Function</i>	<i>P.122</i>
2	<i>Utilities</i>	<i>P.123</i>
3	<i>Initialization and Clearing</i>	<i>P.125</i>
4	<i>Tape Interface</i>	<i>P.130</i>
5	<i>Synchronized Play</i>	<i>P.134</i>

1. Condition Function

Provides check of which screen is currently selected, and of the Pad Banks.

[Step 1] Press **CONDITION**.

The current mode and Pad Bank in effect will be displayed.

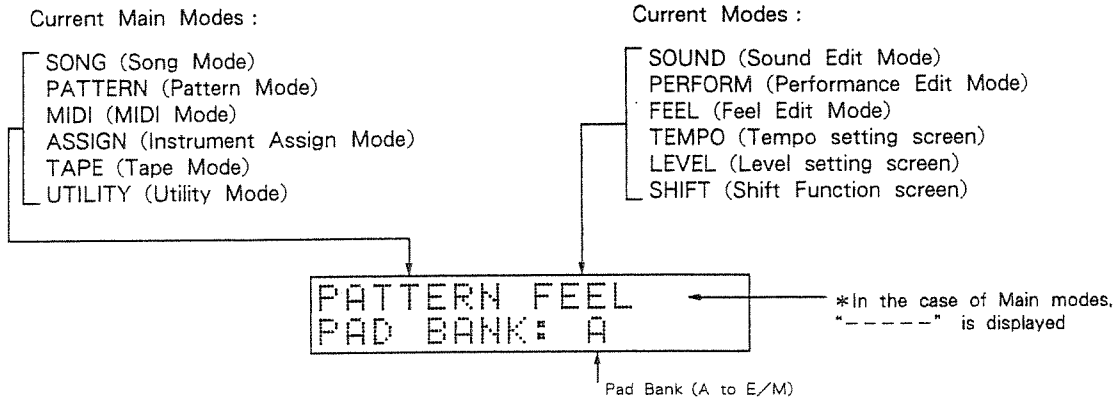

[Step 2] Press **CONDITION** again to return to the original screen.

2. Utilities

In the Utility mode, there are three functions, as follows:

- All Song Clear (erases all songs)
- All Pattern Clear (erases all programmable patterns)
- Available Memory (for checking the amount of memory remaining for songs and rhythm patterns)

1. All Song Clear

Erases all songs contained in memory on the R-5.

[Step 1] Press **UTILITY** to get the Utility mode.

[Step 2] Press Numerical Key **1** to specify "SNGCLR".

```
ALL SONG CLEAR
Press ENTER.
```

[Step 3] Press **ENTER**.
"Are you sure?" will be displayed.

[Step 4] Press **ENTER** once again.
"Completed" will be displayed when all songs have been cleared.

* To cancel the procedure, press **EXIT**.

2. All Pattern Clear

Erases all programmable patterns contained in memory on the R-5.

[Step 1] Press **UTILITY** to get the Utility mode.

[Step 2] Press Numerical Key **2** to specify "PTNCLR".

```
ALL PTN CLEAR
Press ENTER.
```

[Step 3] Press **ENTER**.
"Are you sure?" will be displayed.

[Step 4] Press **ENTER** once again.
"Completed" will be displayed when all patterns have been cleared.

* To cancel the procedure, press **EXIT**.

3. Available Memory

This function allows you to check the amount of memory still available for songs or rhythm patterns, as a percentage value. When remaining memory reaches 0%, no more songs or rhythm patterns can be created.

[Step 1] Press **UTILITY** to get the Utility mode.

[Step 2] Press Numerical Key **3** to specify "AVAIL".

```
AVAILABLE MEMORY
S= 98% P= 33%
```

↑
Remaining memory for songs

↑
Remaining memory for rhythm patterns

The amount of memory still remaining for songs and rhythm patterns is displayed.

[Step 3] Press **EXIT** return to the Menu screen.

3. Initialization and Clearing

This procedure allows you to either restore all settings to their factory defaults, or to return values to the value they had before setting was made. To restore to the factory defaults is termed as “Initialization”, and returning values to what they were before setting is “Clearing”.

1. Initializing the Sound Parameters

The following restores all Sound Parameters to their factory defaults (p.191).

[Step 1] Press **SOUND** to get the Sound Edit mode.

[Step 2] Press Numerical Key **3** to specify “INIT”.

```
SND INIT
[S] SINGLE [A] ALL
```

[Step 3] Select the type of initialization.

● To initialize specific instruments:

Press Numerical Key **1** to specify “SINGLE”.

Instrument to be initialized
↓

```
SND INIT<DRY_K1>
Press ENTER.
```

● To initialize all instruments:

Press Numerical Key **2** to specify “ALL”.

```
SND INIT <ALL>
Press ENTER.
```

If “ALL” has been selected, go to Step 5.

[Step 4] Press the Pad Key corresponding to the instrument you wish to initialize. If necessary, press **PAD BANK** to change Pad Banks.

If you hold down **SHIFT** while pressing **+1/ON** (or **-1/OFF**), you can select the next higher (or lower) numbered instrument.

Hold down **SHIFT** while pressing **SELECT** to listen to the selected instrument.

[Step 5] Press **ENTER**.
"Are you sure?" will be displayed.

[Step 6] Press **ENTER** once again, and the initialization takes place.

* To cancel the procedure, press **EXIT**.

2. Clearing the Performance Parameters

Sets the settings for the Performance Parameters for all Pad Keys to "0" (for Pan, to OFF).

[Step 1] Press **PERFORM** to get the Performance Edit mode.

[Step 2] Press Numerical Key **3** to specify "CLEAR".

```
PFM CLEAR <ALL>
Press ENTER.
```

When you wish to clear the Performance Parameters for all Pad Banks, proceed to Step 4.

[Step 3] Press **PAD BANK** to select the Pad Bank for which you wish to clear the Performance Parameters.

If you want to clear the Multi-Assign Pad Bank, press **MULTI**.

Selected Pad Bank
↓

```
PFM CLEAR <A>
Press ENTER.
```

[Step 4] Press **ENTER**.
"Are you sure?" will be displayed.

[Step 5] Press **ENTER** once again, and the Clear is performed.

* To cancel the procedure, press **EXIT**.

3. Initialization of Instrument Assignment

This enables you to restore all Instrument Assignments to their factory default settings. (see p. 189)

With play stopped, perform the following:

[Step 1] Press **INST ASSIGN** to get the Instrument Assign mode.

[Step 2] Press Numerical Key **2** to specify "INIT".

```
ASSIGN INIT<ALL>
Press ENTER.
```

When you wish to initialize the settings for all Pad Banks, proceed to Step 4.

[Step 3] Press **PAD BANK** to select the Pad Bank for which you wish to initialize the Instrument Assignment.

If you want to initialize the Multi-Assign Pad Bank, press **MULTI**.

```
Selected Pad Bank
↓
ASSIGN INIT<A>
Press ENTER.
```

[Step 4] Press **ENTER**.
"Are you sure?" will be displayed.

[Step 5] Press **ENTER** once again, and initialization takes place.

* To cancel the procedure, press **EXIT**.

4. Clearing Feel Patches

This enables you to return the Feel Patch settings to the value they had before setting was made.

- [Step 1] Press **FEEL** to get the Feel Edit mode.
- [Step 2] Press Numerical Key **1** to specify "PATCH".
- [Step 3] Select the number (0 to 7) of the Feel Patch you wish to clear.
- [Step 4] Press **EXIT** to return to the Menu screen, then press Numerical Key **7** to specify "CLEAR".

```
FEEL CLEAR <#0>
Press ENTER.
```

- [Step 5] Press **ENTER**.
"Are you sure?" will be displayed.
- [Step 5] Press **ENTER** once again, and the Clear takes place.

* To cancel the procedure, press **EXIT**.

5. Initializing the Feel Patches

The following allows you to restore all Feel Patches to their factory presets.

- [Step 1] Press **FEEL** to get the Feel Edit mode.
- [Step 2] Press Numerical Key **8** to specify "INIT".

```
FEEL INITIALIZE
Press ENTER.
```

- [Step 3] Press **ENTER**.
"Are you sure?" will be displayed.
- [Step 4] Press **ENTER** once again, and the Feel Patches will be initialized.

* To cancel the procedure, press **EXIT**.

6. Initialization of Note Numbers

This allows you to restore the note number settings for all instruments to their default settings. (see p. 194)

With play stopped, carry out the following:

- [Step 1] Press **MIDI** to get the MIDI mode.
- [Step 2] Press Numerical Key **1** to specify "IN_SEC".
- [Step 3] Press Numerical Key **4** to specify "NT# INIT".

```
NOTE# INITIALIZE
Press ENTER.
```

- [Step 4] Press **ENTER**.
"Are you sure?" will be displayed.
- [Step 5] Press **ENTER** once again, and initialization takes place.

* To cancel the procedure, press **EXIT**.

7. Initialization of the R-5

All settings on the R-5 can be restored to their factory defaults. At the same time, the demonstration song, and all settings for songs and rhythm patterns are reset, and the Preset Patterns are copied into pattern numbers 00 to 31.

- [Step 1] Turn off the power on the R-5.
- [Step 2] Hold down both **PAGE** and **SELECT** while turning power back on again.

```
SYSTEM INIT
Press ENTER.
```

- [Step 3] Press **ENTER**.
"Are you sure?" will be displayed.
- [Step 4] Press **ENTER** once again, and initialization takes place.

* To cancel the procedure, press **EXIT**.

4. Tape Interface

The data contained in memory in the R-5 can be saved to audio-use recording tape.

1. Saving

This allows data in the R-5's memory to be stored (saved) on tape.

* Each time you save, be sure to follow up by performing Verify (p. 132), so you are sure that the data has been correctly saved.

[Connections]

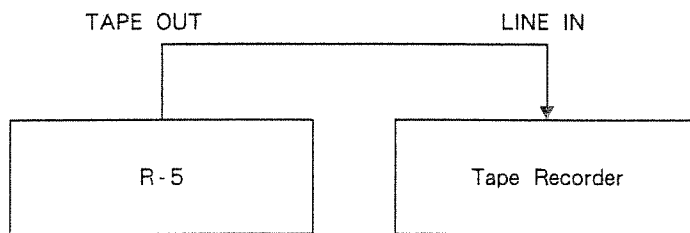

* When saving R-5 data, do not apply any noise reduction or equalization. When due to the design of the tape recorder you use, you must have the signal pass through noise reduction, or the like, make sure that you use the same settings for playback (loading) as you used when recording.

With play stopped, perform the following:

[Step 1] Press **TAPE** to get the Tape mode.

```
LOAD  SAVE
VERIFY
```

[Step 2] Press Numerical Key **2** to specify "SAVE".

```
DATA SAVE
ALL SEQ SETUP
```

[Step 3] Select the data to be saved by pressing a Numerical key, from **[1]** to **[3]**:

1: ALLAll data in the R-5 (SEQ and SETUP)

2: SEQ.....Rhythm patterns and Song data

3: SETUP ...Instrument Assignments/Sound Parameters/Performance Parameters/Feel Patches/MIDI settings/Metronome settings/Sync mode settings.

Once the type of data has been selected, the following screen appears:

Selected Data Type
↓

```

SAVE <ALL>
Are you sure?
  
```

[Step 4] Start recording on the tape recorder.

[Step 5] Wait a few seconds, then press **[ENTER]**.

```

SAVE <ALL>
Saving...
  
```

* When you press **[ENTER]**, the pilot signal (high-pitched tone) will be output for about 6 seconds. When using a tape recorder allowing adjustment of recording level, set the recording level for the pilot signal in the range of from -10 to -3 VU.

* To cancel the procedure, press **[EXIT]**.

[Step 6] After the save has been done, and "Completed" is displayed, stop recording on the tape recorder.

For the saving operation to finish, it will take from 3 to 5 minutes when you have selected "ALL" or "SEQ", and about 20 seconds when it is "SETUP."

[Step 7] Press **[EXIT]** to return to the Menu screen.

2. Verify

Allows you to check (verify) if the data has been correctly saved to tape.

[Connections]

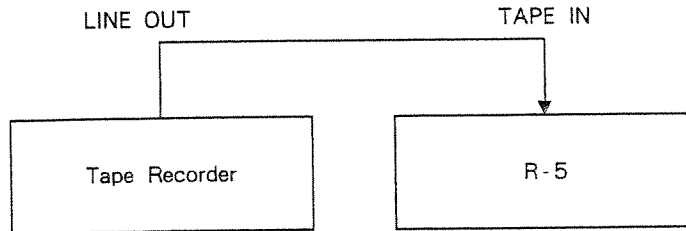

With play stopped, perform the following:

[Step 1] Rewind the tape onto which data was saved. Then in listening to the playback, find where the steady tone changes into a warbling sound, then position the tape so it is stopped a little before that point.

[Step 2] From the Tape mode's Menu screen, press Numerical Key **3** to specify "VERIFY".

```
DATA VERIFY
Press ENTER.
```

[Step 3] Press **ENTER**.
"Are you sure?" will be displayed.

[Step 4] Start playback of the tape.

[Step 5] Press **ENTER**.

- * Press **ENTER** before the steady tone changes to a warble.
- * To cancel the operation, press **EXIT**.

During the verification, "Verifying" is displayed, and the Tempo Indicator will light in green.

When the data is confirmed as being correctly saved, "Completed" is displayed. Press **EXIT** to return to the Menu screen.

Should any errors be detected partway through, "Verify error" will be displayed and the Verify procedure will stop. In such cases, press **EXIT** to return to the Menu screen, then readjust the tape's playback level and try again. When repeated attempts still result in "Verify error", change the recording level, and save the data over again.

3. Load

Loads data saved on tape to the unit.

Connect up the tape recorder and R-5 the same way as for Verify. Then with play stopped on the R-5, do the following:

- [Step 1] Position the tape containing data so that it is stopped just before the steady tone changes into the warble.
- [Step 2] From the Tape mode's Menu screen, press Numerical Key **1** to specify "LOAD".

```

DATA LOAD
Press ENTER.
```

- [Step 3] Press **ENTER**.
"Are you sure?" will be displayed.

- [Step 4] Start playback on the tape recorder.

- [Step 5] Press **ENTER**.

- * Press **ENTER** before the steady tone changes to a warble.
- * To cancel the operation, press **EXIT**.

While data is being loaded, "Loading" is displayed, and the Tempo Indicator will light in green. When the data is properly loaded, "Completed" is displayed. Press **EXIT** to return to the Menu screen.

Should any errors be detected partway through, "Load error" will be displayed and the loading procedure will be cancelled. In such cases, press **EXIT** to return to the Menu screen, then readjust the tape's playback level and try again.

- * You should be able to load data correctly if no errors were found as a result of Verify after the data was saved.

5. Synchronized Play

The R-5 can be synchronized for play with any connected MIDI devices or MTR (Multitrack Tape Recorder).

1. Settings for the Sync Mode

With play stopped in the Song or pattern mode, perform the following:

[Step 1] While holding down **SHIFT**, press Pad Key **I2**.

```
SYNC MODE
*:INTERNAL*
  ↑
Current Sync Mode
```

[Step 2] Select the Sync mode using **-1/OFF**, **+1/ON**.

INTERNAL · · R-5 plays independently/External MIDI devices sync to tempo of R-5.
MIDI · · · · · The R-5 syncs to the clock signal from an external MIDI device.
TAPE · · · · · The R-5 syncs to the sync signal recorded on devices such as an MTR.

[Step 3] Press **EXIT** to return to the original screen.

* When the Sync mode is set to "MIDI" or "TAPE", the Tempo Setting screen will appear as shown below, and the tempo will no longer be controllable on the R-5.

(With MIDI Sync)

```
TEMPO ADJUST
  ↓=MIDI
```

(With Tape Sync)

```
TEMPO ADJUST
  ↓=TAPE
```

Also, during synchronized play, the characters displayed will be in lowercase, such as "midi" or "tape".

* If you press **START/STOP** while an external sync signal has not yet been received, the display for tempo normally appearing when in play will appear, but actual play will not start until the sync signal arrives.

2. MIDI Sync

Allows the R-5 to play while in sync with an external MIDI device.

● When the R-5 is the master

When the tempo or Start/Stop controls on the R-5 are to be used to control an external MIDI device, make connections as shown below:

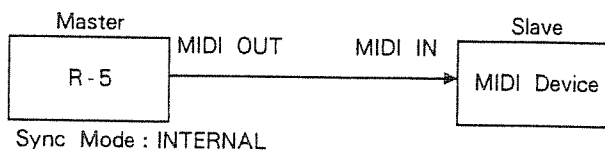

When the slave device is capable of receiving Song Select/Song Position Pointer, song and measure numbers specified on the R-5 are also selected on the slave.

● When the R-5 is the slave

When the tempo or Start/Stop controls on an external MIDI device are to be used to control the R-5, make connections as shown below:

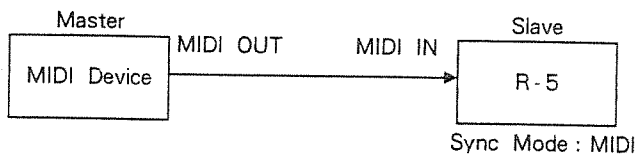

When the master device is capable of transmitting Song Select/Song Position Pointer, song and measure numbers specified on the master device are also selected on the R-5.

3. Tape Sync

The R-5 can be synchronized for play with the sync signal recorded on an MTR.

This allows you to divide a performance on the R-5 into a number of portions for recording to an MTR, or to synchronize another MIDI device which doesn't have Tape Sync capability to the MTR.

● Recording Sync Signals

[Connections]

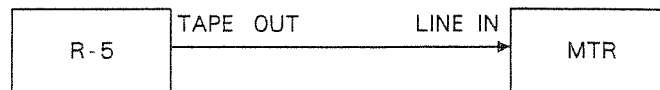

* When recording sync signals do not use any noise reduction or equalization. When due to the specifications of the MTR, you must pass the signal through noise reduction, etc., make sure you use the same settings in playback as you did when recording.

With play on the R-5 stopped, perform the following:

[Step 1] Set the R-5's Sync mode to "INTERNAL". (see p. 134)

[Step 2] Adjust the recording level on the MTR. (about -10 to -3 VU)

* When the R-5 is stopped, the pilot signal (a steady tone) is constantly output from the TAPE OUT Jack.

[Step 3] Set the tempo at which the R-5 is to play.

[Step 4] Start recording on the MTR, and several seconds later, start the R-5.

[Step 5] When play has stopped, wait a few seconds, then stop recording on the MTR.

● Synchronized Play

You can play the R-5 while synchronized to the sync signal recorded on an MTR.

[Connections]



With play on the R-5 stopped, perform the following:

- [Step 1] **Rewind the tape, and then position it so it is stopped just before the steady tone changes into a warble.**
- [Step 2] **Set the Sync mode on the R-5 to "TAPE". (see p. 134)**
- [Step 3] **Start the MTR.**
Have the track with the sync signal in play; the other tracks are put into record as needed.
- [Step 4] **Press START/STOP on the R-5.**

* Press START/STOP before the steady tone changes to a warble.

When the sync signal changes to the warbling sound, play on the R-5 starts, in sync with the signal.

* Synchronism cannot be achieved if the sync signal is started partway through.

* Should you fail to get play to occur in sync, readjust the output level of the MTR's sync signal, and try again. If repeated attempts still fail, change the recording level and record the sync signal again.

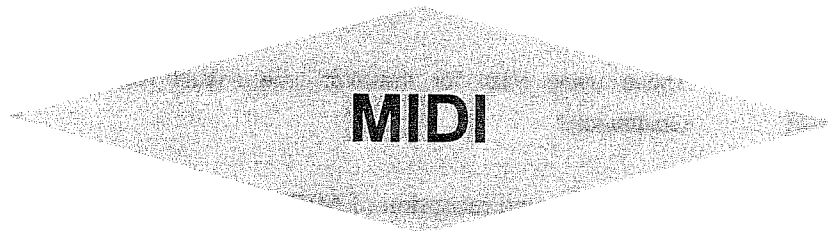

1	<i>Concerning MIDI</i>	<i>P.140</i>
2	<i>Settings for the Instrument Section</i>	<i>P.141</i>
3	<i>Settings for the Performance Section</i>	<i>P.146</i>
4	<i>Function Switches</i>	<i>P.148</i>
5	<i>Data Transfer Using Exclusive</i>	<i>P.151</i>

1. Concerning MIDI

External MIDI devices can be used to play the R-5, or alternately, the R-5's performance data can be used to play an external MIDI sound module. In addition, through use of MIDI Exclusive messages, all internal data can be transferred in bulk to an external MIDI device.

* Those using MIDI for the first time should read the separate booklet, "MIDI Guidebook."

Transmission and reception of MIDI messages is handled as follows on the R-5.

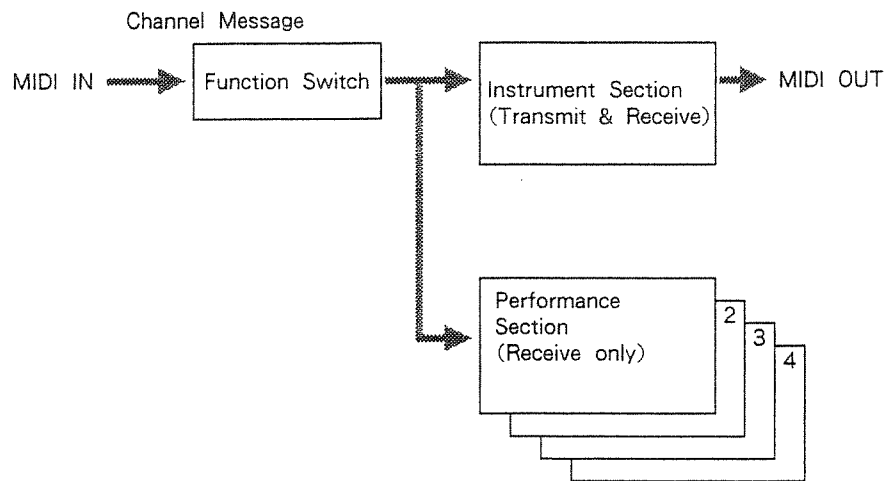

On the R-5, MIDI is organized so as to form one Instrument Section and four Performance Sections.

● Instrument Section (Transmission/Reception)

When the R-5 is to be used as a rhythm module under the control of an external MIDI device, it is set for the Instrument Section. In the Instrument Section, each instrument is assigned a note number, and sounds are played when performance data is received from an external MIDI device.

In addition, the R-5 is set for the Instrument Section when its performance data is being used to play another MIDI sound module.

● Performance Section (Reception)

The R-5 is set for the Performance Section when it is to be played by a MIDI keyboard, much like a synthesizer sound module would be.

In the Performance Section, one instrument is assigned to each of the 4 sections.

The parameters (*Pitch/Decay/Nuance/Pan*) of these instruments (Sections) can then be controlled by the location of keys pressed, modulation lever, etc on the keyboard.

2. Settings for the Instrument Section

The parameters below are set for the Instrument Section.

- * When you use performance data from an external MIDI device to play the R-5's Instrument Sections, play will take place with the sound being in accord with settings for the Sound Parameters. (see p. 94)

1. Receive Channel

Sets the MIDI channel (Receive channel) upon which performance data from an external MIDI device will be received.

When the R-5 is to be played using the Instrument Section, you need to have the external MIDI device's transmit channel set to the same channel as the Instrument Section's Receive channel.

- * The Receive channels of the Instrument and Performance Sections should be set to different channels. If set to the same channel, the Instrument Section takes priority.
- * The Instrument Section's Receive channel becomes the Basic channel on which transmission/reception of Exclusive Messages is carried out.

[Step 1] Press **MIDI** to get the MIDI mode.

```

IN_SEC  PF_SEC
FNC SW  DUMP
  
```

[Step 2] Press Numerical Key **1** and specify "IN_SEC".

```

INST SECTION
CHANNEL  NOTE# →
  
```

[Step 3] Press Numerical Key **1** and specify "CHANNEL".

```

RECEIVE CHANNEL
RX CH= 10      →
  
```

↑
Receive Channel

[Step 4] Set the Receive channel (1 - 16) for the Instrument Section using **-1/OFF**, **+1/ON**.

[Step 5] Press **EXIT** to return to the Menu screen.

2. Transmit Channel

The MIDI channel used to transmit the performance data (Note Messages) of the R-5 is set for each instrument.

When the performance data of the R-5 is to be used to play an external MIDI sound module, you need to set the instrument's Transmit channel and the MIDI sound module's receive channel to the same channel.

* When the unit left the factory, the Transmit channel for all instruments was set to 10.

[Step 1] From the MIDI mode's Menu screen, press Numerical Key **[1]**, and specify "IN_SEC".

[Step 2] Press Numerical Key **[1]** and specify "CHANNEL".

[Step 3] Press **[PAGE]** to get the screen for setting transmit channel.

```

TRANSMIT CHANNEL
(CDRY_K1) = 10  ←
    ↑           ↑
Instrument   Transmit Channel
    
```

[Step 4] Press the Pad Key for the instrument for which you wish to set the transmit channel.
If necessary, press **[PAD BANK]** to change Pad Banks.

* If you hold down **[SHIFT]** while pressing **[+1/ON]** (or **[-1/OFF]**), you can select the next higher (or lower) numbered instrument.

Hold down **[SHIFT]** while pressing **[SELECT]** to listen to the selected instrument.

[Step 5] Set the Transmit channel (1 to 16) using **[-1/OFF]**, **[+1/ON]**.

[Step 6] To make settings for other instruments, repeat Steps 4 and 5.

[Step 7] Press **[EXIT]** to return to the Menu screen.

3. Note Numbers

A Note Number is set for each instrument. Such Note Numbers determine which instrument is to be sounded corresponding to which number, when note messages are received on the Instrument Section's Receive channel.

In addition, the note numbers set here are used when the R-5 transmits performance data.

* For information on the factory default settings for Note Numbers, refer to p. 194.

* Even after Note Numbers have been changed, they can at any time be restored to their factory default settings by performing initialization (see p.129).

[Step 1] From the MIDI mode's Menu screen, press Numerical Key **1** and specify "IN_SEC".

[Step 2] Press Numerical Key **2** and specify "NOTE#".

```
NOTE NUMBER
(CDRY_K1)= 035
```

[Step 3] Press the Pad Key for the instrument for which you wish to set the Note Number.
If necessary, press **PAD BANK** to change Pad Banks.

* If you hold down **SHIFT** while pressing **+1/ON** (or **-1/OFF**), you can select the next higher (or lower) numbered instrument.

Hold down **SHIFT** while pressing **SELECT** to listen to the selected instrument.

[Step 4] Set the Note Number (0 to 127) using **-1/OFF**, **+1/ON**.

* Instruments for which Note Messages are not to be transmitted/received should be set to "OFF."

[Step 5] To make settings for other instruments, repeat Steps 3 and 4.

[Step 6] Press **EXIT** to return to the Menu screen.

4. Control Change

Reception of Control Change

The timbre of instruments can be put under the control of Control Changes received from an external MIDI device. With regard to the 9 types of Control Changes (Modulation and General Purpose Controllers 1 to 8), you need to make setting for both the instrument for which timbre is to be controlled, and the parameters to be altered (Pitch/Decay/Nuance/Pan).

* With the Pan Switch (Function Switch , p. 149) set to "ON", any Pan set for Control Changes becomes invalid.

Transmission of Control Change

Settings made for Control Changes are transmitted also when the R-5 is in play.

Through making settings for Control Changes, along with playing the specified instrument during play, the R-5 at the same time transmits a Control Change (the value of a specified parameter).

After recording in real-time in a sequencer certain performance data, and then using it to play the R-5, the changes in timbre for the instruments can be reproduced faithfully. (p. 160)

[Step 1] From the MIDI mode's Menu screen, press Numerical Key **[1]** and specify "IN_SEC".

[Step 2] Press Numerical Key **[3]** and specify "CTRL".

```
CONTROL CHANGE
CTRL=*MODUL*  →
```

↑
Types of Control Change

[Step 3] Select the type of Control Change using **[-1/OFF]**, **[+1/ON]**.

Control Change	Control Change Number
MODUL	1
CTRL - 1	16
CTRL - 2	17
CTRL - 3	18
CTRL - 4	19
CTRL - 5	80
CTRL - 6	81
CTRL - 7	82
CTRL - 8	83

[Step 4] Press **PAGE** to get the screen used to specify instruments.

Selected Control Change
↓
MODULATION
\$INST = (DRY_K1) ←
↑
Instrument to be changed with Control Change

[Step 5] By pressing Pad Keys, select the instrument to be changed by Control Change.
If necessary, press **PAD BANK** to change Pad Banks.

* If you hold down **SHIFT** while pressing **+1/ON** (or **-1/OFF**), you can select the next higher (or lower) numbered instrument.

Hold down **SHIFT** while pressing **SELECT** to listen to the selected instrument.

[Step 6] Press **SELECT** to choose "PARAM".

MODULATION
\$PARAM = *OFF* ←
↑
Parameter to be changed

[Step 7] Select the parameter (PITCH/DECAY/NUANCE/PAN) that is to be changed by Control Change using **-1/OFF**, **+1/ON**.

When Control Change is not to be used, it is set to "OFF".

* Pitch cannot be chosen for use with General Purpose Controllers 5 through 8.

[Step 8] When other Control Changes are to be set, press **PAGE** to switch screens, then repeat Steps 3 through 7.

[Step 9] Press **EXIT** to return to the Menu screen.

3. Settings for the Performance Section

The parameters below are set for the Performance Section.

* The basic timbre of the sound is set by means of the Sound Parameters (see p.94).

●Receive Channel

With regard to each Performance Section, a channel (Receive channel; 1 - 16) on which performance data is to be received is set.

When the Performance Section is used for playing sounds, you need to have the transmit channels on the external MIDI device set to the same channels as the receive channels in the Performance Section.

Any Receive channels in the Performance Section that are not being used should be set to "OFF"

* The Receive channels of the Instrument and Performance Sections should be set to different channels. If set to the same channel, the Instrument Section takes priority.

●Instruments

For each Performance section, an instrument which is to be controlled is set.

●Parameters

For each specified instrument, one parameter which is to be changed using Note Numbers is selected. (pitch/decay/nuance/pan)

●Center note Number

Sets the Note Number (0 - 127) that becomes the base reference for changes in parameters. When Center-Note-Number Note Messages are received, play occurs in accord with Sound Parameter settings.

●Keyboard Follower

Sets the value of parameter change between two Note Numbers.

Parameter	Variable Range
Pitch	0 - 990
Decay	0 - 9
Nuance	0 - 3
Pan	0 - 1

Using the Center Note Number as a reference, with each increase in note number (or decrease), a value of change is added (or subtracted) to the Sound Parameter.

●Modulation

Selects the parameter (Pitch/Decay/Nuance/Pan) which will be controlled as a result of Modulation in Control Change.

When Modulation is set, you can do things such as change Pitch using the keyboard while controlling Decay with the modulation lever.

* Modulation should be set to "OFF" when not being used.

[Step 1] Press **MIDI** to get the MIDI mode.

[Step 2] Press Numerical Key **2** to specify "PF_SEC".

```
PERFORM SECTION
SECTION= 1
```

↑
Performance Section 1 to 4

[Step 3] Select the Performance Section (1 to 4) which is to be set using **-1/OFF**, **+1/ON**.

[Step 4] Press **PAGE** to get the parameter setting screen.

```
PFM SECTION 1
$RX CH = OFF
```

↑ ↑
Parameter Value

[Step 5] Select the parameter to be set by pressing **SELECT**

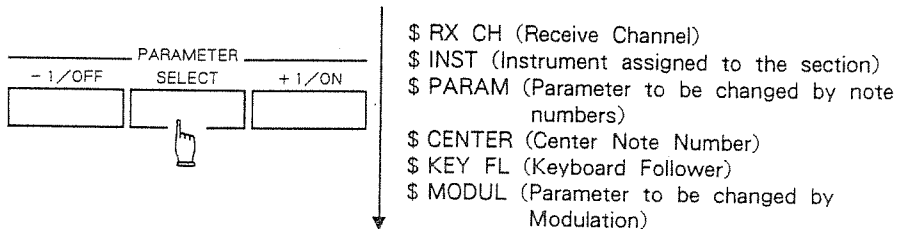

[Step 6] Set the parameters using **-1/OFF**, **+1/ON**.

"\$INST" is specified using the Pad Keys.

* If you hold down **SHIFT** while pressing **+1/ON** (or **-1/OFF**), you can select the next higher (or lower) numbered instrument.

Hold down **SHIFT** while pressing **SELECT** to listen to the selected instrument.

[Step 7] To set other parameters, repeat Steps 5 and 6.

[Step 8] Press **EXIT** to return to the Menu screen.

4. Function Switches

Accept settings determining whether or not MIDI Channel Messages are transmitted/received.

Individual settings can be made for: Note Off, Pan, Program Change, and Exclusive.

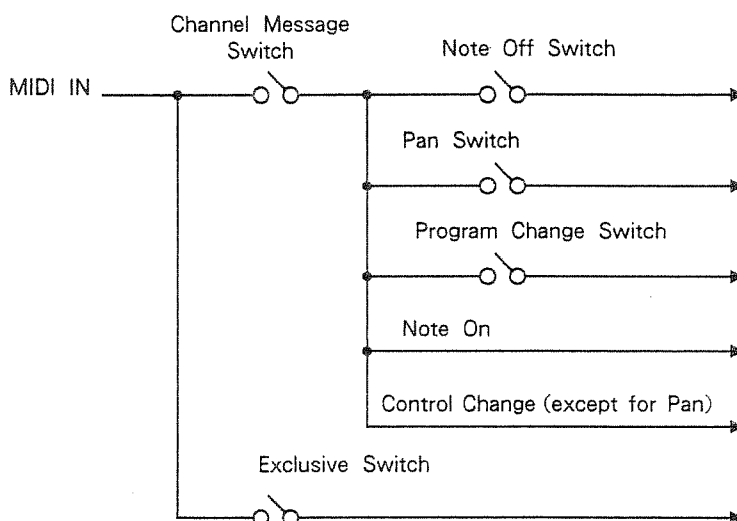

* Settings for Function Switches relate to all Sections.

How Function Switches Work

● Channel Message Switches

Accept settings determining whether Channel Messages (Note Messages, Program Changes, Control Changes) are received/transmitted or not.

ON: Channel Messages are received/transmitted

OFF: All Channel Messages are not received/transmitted regardless of the settings for the Note Off, Pan, and Program Change Switches.

Ordinarily, they are set to "ON."

● Note Off Switch

Determines whether or not Note Off messages (or a note on Velocity of 0), such as those produced when a key on a MIDI keyboard is released are received.

ON: Starting at the moment a Note Off is received, the instrument with the corresponding Note Number is muted.

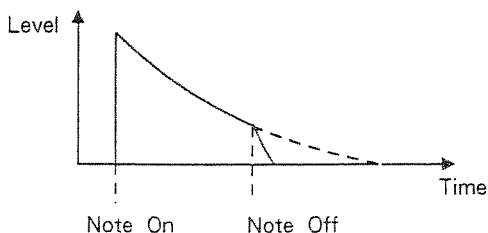

OFF:.....Even if Note Off is received, the instrument with the corresponding Note Number continues sounding until it finishes.

Ordinarily it is set to "OFF" but if you wish to mute sounds having long decays, set to "ON."

* When using note data from an external MIDI device to write in real-time, Note Off cannot be used to gain a mute effect in a rhythm pattern.

●Pan Switch

Selects whether or not Pan data (Control number 10) is to be received from an external MIDI device.

ON:.....When Pan is received, the pan orientation is put in effect for the instrument (or all instruments when it is an Instrument Section) of the Section receiving the messages, and remains that way until Pan is received again.

OFF:.....Pan will not be received.

* When the Pan Switch is set to "ON", all other assignments for Pan made for Control Change Numbers (MODUL/CTRL 1 -8) become invalid. (p. 144,146)

●Program Change Switch

Selects whether or not Program Changes are received.

ON:.....Pattern and Feel Patch numbers are changed in accord with Program Change numbers received on the Basic channel (Receive channel of the Instrument Section).

Mode	Receivable Range	Operation
Song Play Mode	1 - 8/128	Changes to the Feel Patch that is one number smaller than the receiving number. * "128" will cancel the assignment of the Feel Patches.
Pattern Play Mode	1 - 100	Changes to the Rhythm Pattern that is one number smaller than the receiving number.

OFF:.....No Program Changes are received.

* Even with Program Change set to "ON", in modes other than Song Play and Pattern Play, no Program Changes are received.

* If the Program Change Switch is set to "ON" at the time of song play, any Feel Patches assigned to each rhythm pattern become invalid upon reception of Program Changes.

From start of the song, until the time Program Changes are received, however, play takes place using the Feel Patches assigned to each rhythm pattern.

● **Exclusive Switch**

Selects whether or not to receive MIDI Exclusive Messages.

ON: With play stopped, Exclusive Messages can be received at any time.

OFF: Exclusive Messages are not received.

To set the Function Switches, do as follows:

[Step 1] Press **MIDI** to get the MIDI mode.

[Step 2] Press Numerical Key **3** to specify "FNC SW".

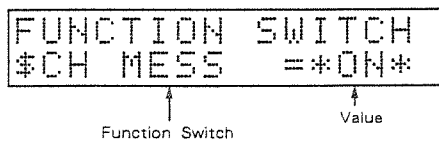

[Step 3] Select the Function Switch you wish to set by pressing **SELECT**.

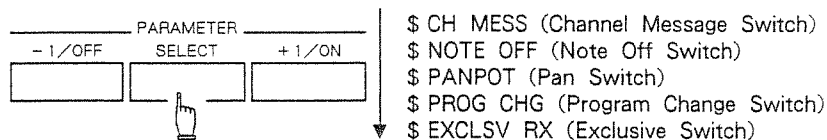

[Step 4] Set ON or OFF using **-1/OFF**, **+1/ON**.

[Step 5] To set other Function Switches, repeat Steps 3 and 4.

[Step 6] Press **EXIT** to return to the Menu screen.

5. Data Transfer Using Exclusive

Through the use of MIDI Exclusive Messages, the data stored in the R-5 can be transferred in bulk to another R-5, or any MIDI device capable of receiving Exclusive Messages.

1. Transmission (Bulk Dump)

Transmits the data stored in the R-5.

[Connections]

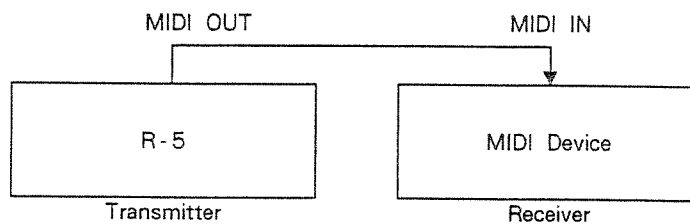

[Step 1] Set both the R-5's Basic channel (Instrument Section's Receive channel) and the Basic channel on the MIDI device at the receiving end to the same channel. (see p. 141)

[Step 2] From the MIDI mode's Menu screen, press Numerical Key **4** and specify "DUMP".

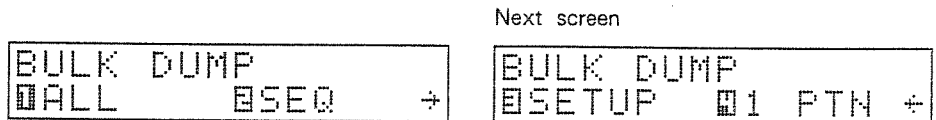

[Step 3] Press a Numerical Key, **1** to **4**, to select the data to be transferred:

- 1: ALLAll data in the R-5 (SEQ and SETUP)
- 2: SEQ.....Rhythm patterns and Song data
- 3: SETUP ...Instrument Assignments/Sound Parameters/Performance parameters/Feel Patches/MIDI settings/Metronome settings/Sync mode settings.
- 4: 1 PTNThe data in one rhythm pattern (programmable patterns only)

Once the type of data has been specified, the following display appears:

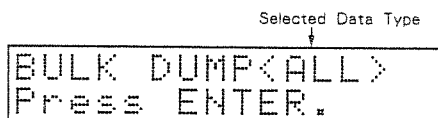

When "1 PTN" has been selected, use **-1/OFF**, **+1/ON** to select the number of the pattern to be transferred.

Pattern Number
↓

BULK DUMP<P01>
Press ENTER.

[Step 4] Press **ENTER**.
"Are you sure?" will be displayed.

* To cancel the procedure, press **EXIT**.

[Step 5] Press **ENTER** once again, and the data transfer begins.
When the transfer has completed, "Completed" is displayed.

● Transfer of Sound Parameters

Exclusive Messages can be used to transfer the Sound Parameters of specific instruments.

[Step 1] Set both the R-5's Basic channel (Instrument Section's Receive channel) and the Basic channel on the MIDI device at the receiving end to the same channel. (see p. 141)

[Step 2] From the Sound Edit mode's Menu screen, press Numerical key **I** to specify "EDIT".

[Step 3] Press the Pad Key for the instrument having the Sound Parameters you wish to transfer.
When necessary, change Pad Banks by pressing **PAD BANK**.

* If you hold down **SHIFT** while pressing **+1/ON** (or **-1/OFF**), you can select the next higher (or lower) numbered instrument.

Hold down **SHIFT** while pressing **SELECT** to listen to the selected instrument.

[Step 4] When **ENTER** is pressed, the currently set Sound Parameters will be transferred.

[Step 5] Press **EXIT** to return to the Menu screen.

2. Reception

Exclusive Messages from another R-5, or an external MIDI device can be received by the R-5.

[Connections]

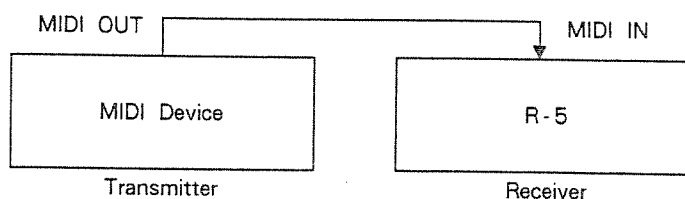

[Step 1] Set both the R-5's Basic channel (Instrument Section's Receive channel) and the Basic channel on the MIDI device at the transmitting end to the same channel. (see p. 141)

[Step 2] Set the Exclusive Function Switch to "ON". (see p. 150)

Whenever play is stopped on the R-5, it is continually ready for reception of Exclusive Messages.

During reception of Exclusive Messages, the display will appear as shown below:

```
BULK LOAD  
Receiving...
```

* Whenever rhythm pattern-use memory becomes full during reception of Exclusive Messages, "Ptn mem full" is displayed and the reception is terminated.

In such cases, either reduce the volume of data being transferred, or clear unneeded rhythm patterns, and then try the operation again.

Getting the Most out of The R-5

In this chapter, a number of actual examples will be used in explaining applications you may want to try with the R-5.

1. Connection with an external MIDI device	156
The R-5 becomes a MIDI sound module	156
Using an external MIDI sound module to accompany play on the R-5 ..	157
Using a sequencer to organize the R-5's performance data	158
2. Creation of Rhythm Patterns	162
Using open hi-hat for input of hi-hat	162
Using Roll during input of hi-hat	162
Inputting accents	162
Making a new rhythm pattern using the editing functions	162
Playing chords with one instrument	164
3. Creation of Songs	165
Fade-in and fade-out	165
4. Adding Effects	166
Using REST for mutes	166
Getting a stereo reverb for the snare	167
Effects with the crash cymbal	167
5. Feel Patches	168
Changing at random the hitting position for the ride cymbal	168
Creating a Feel Patch for a 16 beat hi-hat	168

1. Connection with an external MIDI device

The R-5 becomes a MIDI sound module

The R-5 can be controlled by means of external sequencers, MIDI keyboards, MIDI drum pads, and the like.

Connect up as shown below:

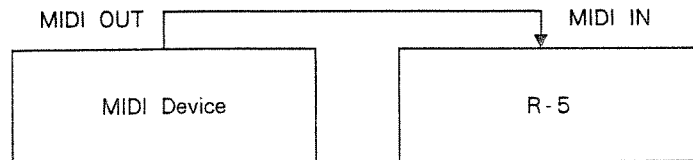

● To use the R-5 as a rhythm module

Using the Instrument Section, the R-5 can be played by an external MIDI device.

- [Step 1] Set the Channel Message Switch to "ON" (p. 148).
- [Step 2] Match the Transmit channel on the external MIDI device with the Receive channel for the Instrument Section (p. 141)
- [Step 3] When necessary, change the instrument's Note Number (p. 143).
- [Step 4] When you play the external MIDI device, the R-5 is played.

If you are set to Real-time Write, everything played can be input to a rhythm pattern.

Control Changes sent from an external MIDI device can be used to change the timbre of instruments (p.144). At such times, the timbre produced by the R-5 corresponds to the most recently received Control Change Message. Therefore, in cases where you want to make timbre changes for each note, each time you need to have a Control Change sent immediately before each Note Message.

● Using the R-5 as a sound module with a MIDI keyboard

If you assign a bass or agogo sound to the R-5's Performance Section, a melody can be played using a MIDI keyboard.

- [Step 1] Set the Channel Message Switch to "ON" (p. 148).

- [Step 2] Match the Transmit channel on the external MIDI device with the Receive channel for the Performance Section (p. 146)
- [Step 3] [1] Assign the instrument to be used at “INST” in the Performance Section.
[2] Set “PARAM” at PITCH, and “KEY FL” at 100.
Any other parameters should be set as needed. (p. 146)
- [Step 4] When the MIDI keyboard is played, the R-5 will play.

If you are set to Real-time Write, everything played on the MIDI keyboard can be input to a rhythm pattern.

Using an external MIDI sound module to accompany play on the R-5

A MIDI sound module can be played along with the R-5. For example, part of a rhythm pattern created on the R-5, such as a snare pattern, can be played using a sampler’s sound.

Creation of performance data

The performance data is created using the procedures ordinarily used for Pattern and Song Writing. For sounds to be played by the external module, input should be made using instrument number 68 (REST), or an instrument that won’t be used onboard. When you are going to use multiple sound modules, or multiple sounds in a module, use an equivalent number of separate instruments for input.

Settings at the time of performance

Connections are made as follows:

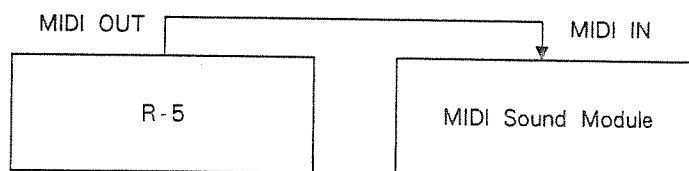

- [Step 1] Match the transmit channel (p. 142) for the instrument input for use by the module with the Receive channel on the external sound module.
- [Step 2] Match the Note Number of the instrument input for use by the module, and the sound on the external module you wish to have played. (p. 143)
- [Step 3] Set the R-5 Channel Message Switch (p. 148) to “ON”.
- [Step 4] Set the level of the instrument input in the pattern to be used by the external module to “0”. This way, unneeded sounds will not be output from Stereo Out (p.106).

* If you have used REST for input, the above will not be necessary.

[Step 5] When you now start play on the R-5, the external sound module will play in accord with the pattern input.

* Should you be using a sampler or synthesizer, certain portions may not play, or some sounds might be broken off.

Using a sequencer to organize the R-5's performance data

It may be convenient for you to use a sequencer's disks for storing, along with synthesizer or sampler data, the performance data for the R-5. This can be done after it has been bulk dumped to the sequencer.

If your sequencer is equipped with a function for handling data in bulk, you can transfer the R-5's data to the sequencer using the procedure explained on page 151, "5. Data Transfer Using Exclusive".

* Depending on the sequencer, the operations explained in this manual may not proceed in the same way. Refer to the manual for your sequencer for further information.

Make connections as shown below:

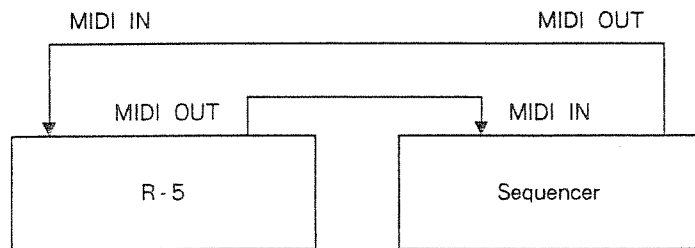

● When the sequencer cannot handle bulk data

Recording Bulk Dump data

The following transfers the R-5's performance data to the sequencer.

[Step 1] Set the R-5's Sync mode to "MIDI" (p. 134).

[Step 2] Make settings so that Real-time Messages are not output from the sequencer.

* In cases where the sequencer used does not permit the setting in Step 2, disconnect the connectors at MIDI OUT on the sequencer, and MIDI IN on the R-5.

[Step 3] Set the sequencer so that it is ready to record. Also make sure that it is set so that any other performance data that has been recorded in the sequencer will not be played back.

[Step 4] Perform the Bulk Dump, using “ALL” (p. 151).

[Step 5] Once “Completed” has appeared in the display, stop the sequencer.

Load and play of performance data

After the data in the sequencer memory has been loaded, it can be played on the R-5 while synchronized with the sequencer.

[Step 1] Have the Song Play screen showing on the R-5.

[Step 2] Set the sequencer so that no Real-time Messages are output.

* When the sequencer does not permit the setting in Step 2, set the Sync mode on the R-5 to “INTERNAL” (p. 134).

[Step 3] Set the Exclusive Switch on the R-5 to “ON” (p. 150).

[Step 4] Play the song or track on the sequencer, for which the bulk data dump was done, and load the performance data to the R-5.

The Sync mode of the R-5 will automatically turn to “MIDI”.

[Step 5] Set so Real-time Messages can be output from the sequencer.

[Step 6] When the song or track on the sequencer, in which is contained the performance data for use by an external MIDI sound module, is played, the R-5 will start play in sync with it.

● Recording into a sequencer in real-time the performance data of the R-5.

The MIDI data transmitted by the R-5 during play can be recorded in real-time to a sequencer, and that performance data can then be organized and stored by the sequencer. The advantage to this is that unlike a Bulk Dump, the data can afterwards be edited on the sequencer. In addition, if you use Control Changes, the sound changes during performance can also be recorded.

In order to get a faithful reproduction of the original performance, record the setup data (Sound Parameters, Note Numbers, and settings for Control Change) onto the sequencer as well, by doing a Bulk Dump of the "SETUP".

Recording setup data

- [Step 1] Set the Channel Message Switch (p. 148) to "ON".
- [Step 2] Set the Note Numbers for all instruments used in the song to be recorded. (p. 143) Each instrument should be set to a different number.
- [Step 3] Set the Transmit channels for all instruments used in the song to be recorded (p. 142) so that they match the Receive channel of the Instrument Section. (p. 141)
- [Step 4] When you wish to record as well the sound changes of the Sequence Parameters, make setting for the Instrument Section's Control Change. (p. 144)
- [Step 5] Using the same procedure as in [Recording Bulk Dump data], page 158, the Bulk Dump data is recorded. For the data to be transferred, specify "SETUP" and set the R-5's Sync mode (p.134) to "INTERNAL".

When you already have sampler- or synthesizer-use data recorded in the sequencer, record the setup data as follows:

- [1] In order to record the setup data, you need to insert a number of measures that have no performance data at the beginning of each track.
It takes about 5 seconds to transfer the setup data. You should allow some leeway in terms of time when choosing the number of measures to insert.
- [2] Record the setup data into the beginning portion of the tracks in which the R-5's performance data is to be recorded.

Recording performance data

- [Step 1] Set the R-5's Sync mode to "INTERNAL", and the sequencer to "MIDI". (p. 134)
- [Step 2] Have the sequencer readied so that it will start recording from the measure coming after those where the setup data has been stored.
- [Step 3] On the R-5 select the song to be recorded. Then, hold down **SHIFT** while pressing **START/STOP**, and the performance data can be recorded onto the sequencer.

Play using a sequencer

- [Step 1] Set the R-5's Sync mode to "INTERNAL"; and the sequencer should also be set to an internal mode. (p. 134)
- [Step 2] Set the Exclusive Switch on the R-5 to "ON" (see p.150)
- [Step 3] When the sequencer is started, and the setup data is loaded, the MIDI data from the sequencer starts play of the R-5.

2. Creation of Rhythm Patterns

Using open hi-hat for input of hi-hat

Instead of the closed hi-hat, the open hi-hat can be used first for input to express sounds such as a half-open hi-hat. After input to the rhythm pattern has been made, the Decay of each note can then be edited using the Sequence Parameters (see p. 58) to reach a precise range of expression covering various hi-hat playing techniques.

Using Roll during input of hi-hat

When using Real-time Write, and inputting hi-hat for a 16 beat rhythm, rather than hitting the Pad Key 16 times, you can do it more easily by using Roll. After matching both the Interval for Roll and the setting for Quantize, hold down **ROLL** while pressing the hi-hat Pad Key. You can adjust the strength of the accent by changing the pressure you use in pressing the Pad Key.

Inputting accents

How accents are handled often is the key to making rhythm patterns that are full of expressive energy. What is first obvious in creating accents is to hit the Pad Key harder on certain beats during input. But you might try going further, and at the timing of the accents, raise the Pitch by 10 to 20 cents. The performance should then sound more realistic.

Making a new rhythm pattern using the editing functions

Through combined use of the rhythm pattern editing functions, a new rhythm pattern can be created based on one made previously, or on one of the Preset Patterns.

Here explained are the methods used in creating one rhythm pattern after taking a pattern each, the kick, snare, and hi-hat, from the three example patterns shown below.

Rhythm Pattern A

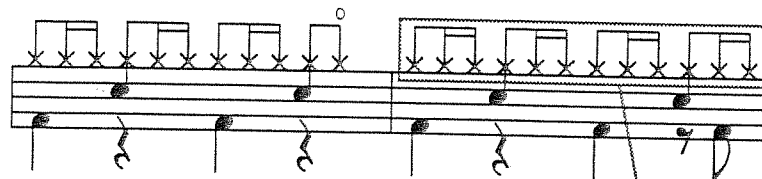

Rhythm Pattern B

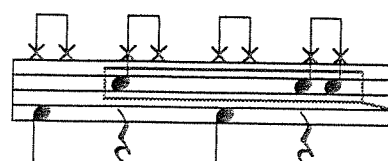

Rhythm Pattern C

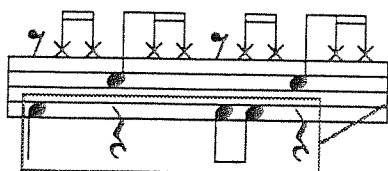

Hi-hat

Rhythm Pattern E



Snare

Kick

- [Step 1] Use **Pattern Copy** to copy portions of the 2nd measure in rhythm pattern A to rhythm pattern D (using an empty pattern number). (p. 54)
- [Step 2] Use **Pattern Extract** to extract the hi-hat pattern from rhythm pattern D to rhythm pattern E. (p. 50)
- [Step 3] Use **Pattern Extract** to extract the snare pattern in rhythm pattern B to rhythm pattern D.
- [Step 4] Using **Pattern Merge**, the snare pattern extracted to rhythm pattern D is merged into rhythm pattern E. (p. 52)
- [Step 5] Extract the kick pattern in rhythm pattern C to rhythm pattern D.
- [Step 6] The kick pattern extracted to D is then merged into rhythm pattern E, using **Pattern Merge**.

The desired rhythm pattern has thus been created in rhythm pattern E.

Playing chords with one instrument

By employing Copy Instruments, instruments such as agogo, that are pitched, can be played in chords.

- [Step 1] Starting with a desired instrument, register as Copy Instruments enough copies of the instrument to fulfill the number of sounds needed for the chords. (p. 100)
- [Step 2] The Copy instruments that have been registered are assigned to the Pad Keys. (p. 88). Then their pitch is adjusted by editing the Performance Parameters (p. 102). Also, the Assign Type should be set to "POLY". (p. 96)
- [Step 3] Using Pattern Write the instruments, for which pitch has been set, are input in order to form chords.

There are only two sticks

In using a drum machine it is often easy to forget that a live drummer only uses two sticks. Thus, other than the kick drum and pedaled hi-hat, there are only two sounds that would be played simultaneously. So, for example, when a 16 beat rhythm is being played with both hands on the hi-hat, and a snare is played along with it, in order to get a more natural sounding performance, the hi-hat should not be input at the same timing as the snare.

3. Creation of Songs

Fade-in and fade-out

Through use of a combination of Repeat (p.70) and Level Change (p.72) with song data, fade-in and fade-out can be obtained.

● Fade-in

Input data as shown below at the beginning of the song, and set the Initial Level to 0 (p.79).

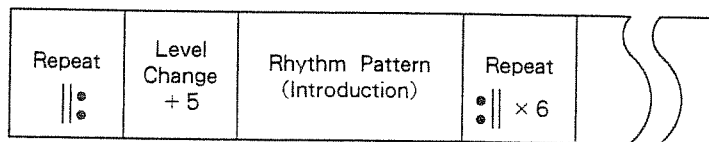

The rhythm pattern enclosed by Repeats will repeat while gradually increasing in volume.

● Fade-out

At the end of the song, input the data as shown below:

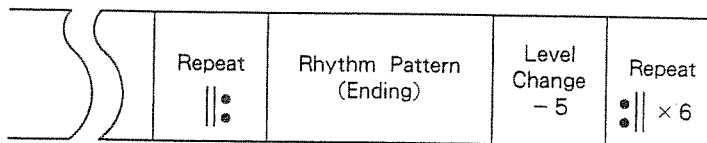

The rhythm pattern enclosed by Repeats will repeat while gradually reducing in volume.

4. Adding Effects

Using *REST* for mutes

Since the instrument called REST (Instrument #68) has no sound data, when it is assigned to a Pad Key nothing will be heard there. Using this feature, you can create rhythm patterns employing a choke technique, or gated drums.

● Muting the decay of the cymbal

Set the Assign Type (p. 96) of the cymbal and REST to the same EXC number. Then if you press **REST** after the cymbal plays, you can mute the cymbal's decay.

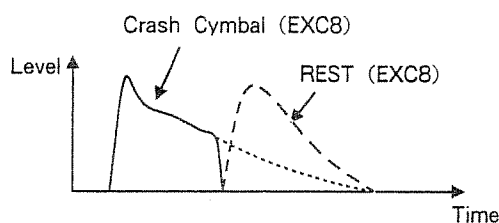

Such effects obtained by using REST to mute sounds can be written into a rhythm pattern, and can be used in performance to provide a mute at a timing that corresponds to a certain tempo.

In such cases, if you repeatedly play the cymbal, each time it is played the previous sound will be muted. Therefore, you should make a Copy Instrument of the cymbal with Assign Type at POLY beforehand, and then use the two types of cymbal as needed.

● Gated drum

If you set the Assign Type of the RVB_S snare (instrument #18) and REST to the same EXC number, and then press REST after the snare has played, you can get the same effect as you would if the reverb on the snare were gated.

Getting a stereo reverb for the snare

The "RVB_S" snare (Instrument#18) contains a large amount of reverb. Thus, as shown below, sounds having little velocity can be shifted at short intervals to left and right, using Scope Steps units (Scope Steps 2 and 3) to obtain a stereo effect.

```

505...1 $VL= 127 ←
■■■--- (RVB_S)
  
```

	●	●	●
\$ VL	127	60	60
\$ PT	0	-4000	-4000
\$ PN	C	R3	L3

As shown, when the Pitch of Scope Steps 2 and 3 is lowered, the reverb becomes more like a reverb. In addition to pitch, if you edit Decay or Nuance the reverbed sounds can be adjusted.

Settings for the timing sounds play and the Sequence Parameters can be carried out using the Scope function in Step Write. (p. 62)

* Set the Assign Type for "RVB_S" at "POLY" (p.96).

Effects with the crash cymbal

If you set the Roll Resolution to "HIGH" (p. 34) and then after using Roll to input the crash cymbal, you make continuous changes in the Pitch of the Sequence Parameters, from -4800 to +4800, you can obtain special effects. The Pitch is set using the Sequence Parameters Real-time Editing, and is done using the VALUE slider. (p. 60)

5. Feel Patches

Changing at random the hitting position for the ride cymbal

If you change the Nuance of the ride cymbal with the Feel Patch's Random Factor, you can express subtle differences in the striking position, and the resulting natural changes in the timbre.

- [Step 1] Using the Instrument Select setting for the Patch, select the ride cymbal. (p. 111)
- [Step 2] Set the Random Factor Switch for Nuance to "ON" (p. 111).
- [Step 3] Set the Probability and Random Depth for Nuance at appropriate values. (p. 111)
- [Step 4] Using the Instrument Switch for Nuance, set the ride cymbal at "ON" (p. 112).
- [Step 5] Assign (p. 118) the set Feel Patch to the rhythm pattern that uses the ride cymbal, and the timbre of the ride cymbal will vary subtly with each note.

Creating a Feel patch for a 16 beat hi-hat

Here we introduce one example of creating a Feel Patch for a 16 beat hi-hat. Set the Groove as follows using Groove Select.

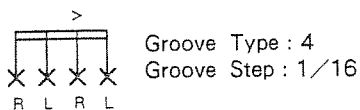

Using Groove, you can simulate a performance on hi-hat by a right-handed drummer, playing alternately with both hands.

- 1 For the place getting an accent, the Velocity is set to +99, and the Pitch is raised by +1 to +2 (10 to 20 cents). For the remaining three times, the Velocity is set lower. For the times the right hand is used though, values should be set higher, but not as high as the accents.
- 2 The Decay at places other than accents should be at about -1 to -2. To try for more realism, it might be better to have -1 for the right hand, and -2 for the left.
- 3 The Nuance should be set negatively for the accents (nearer to edge), and for the left hand, a positive value is good (near the cup). The performance will be more natural if you don't go to extremes.

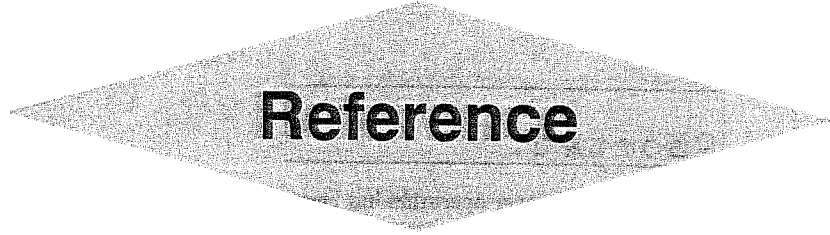

1. Error Messages

Whenever certain problems occur during operation, an error message will be displayed. In such cases look for the item among the error messages below, and follow the explained course of action.

```
Aborted.
```

- Displayed whenever operation has been stopped partway through, or an operation cannot be completed.

```
Ptn mem full!!
```

- No more rhythm patterns can be stored. (Press **EXIT** to return to the original screen.)
- ☐ If you wish to continue with pattern writing, first clear unneeded rhythm patterns. (a total of 2,600 notes can be used for 100 programmable patterns)
- ☐ Should this messages be displayed during reception of Exclusive Messages, you will need to either reduce the volume of data being transferred, or clear unneeded rhythm patterns.

```
No area.
```

- There is not enough memory to perform the editing of the rhythm pattern.
- ☐ Erase unneeded rhythms patterns first, then try again.

```
Bar# overflow.
```

- The number of measures for the pattern would exceed 99 as a result of Pattern Append.
- ☐ Change settings so that the number of measures will be less than 99.

```
Empty pattern.
```

- There is no data in the rhythm pattern that is to be the original, with Pattern Copy or Pattern Merge.
- ☐ Change the rhythm pattern becoming the original.

Memory full.

● No more songs can be stored.

☞ If you wish to continue Song Writing or Editing, erase unneeded songs.

Empty song.

● There is no data in the song targeted for Search Label, Part Delete, Part Copy, etc.

☞ Use such functions only with songs having performance data.

Part overlap.

● With Part Copy, the specified range of Parts and their destination will overlap.

☞ Reset settings so they are correct.

No part.

● There is no performance data in the Part specified for Part Copy or Part Delete.

☞ Reset settings so they are correct.

Part# overflow.

● If the Part Insert or Part Copy is carried out, the number of Parts in the song will exceed 999.

☞ Redo settings so that the number of Parts will be less than 999.

Verify error !

● The R-5 data has not been correctly saved onto tape. (Press **EXIT** to return to the original screen.)

☞ Try the operation again after changing the level for playback. If again the error message appears, the Save procedure should be performed again.

Load error !

●The data recorded on tape could not be loaded correctly. (Press **EXIT** to return to the original screen.)

☐ Try loading again after changing the level for playback.

Check sum error!!

●The Exclusive Messages could not be received correctly. (Press **EXIT** to return to the original screen.)

☐ Try doing the operation over again.

MIDI buf full!!

●An amount of MIDI data in excess of what could be processed was received (or transmitted) at one time. (Press **EXIT** to return to the original screen.)

☐ If displayed during reception, reduce the amount of MIDI data on the transmitting end.
☐ To avoid receiving unnecessary MIDI data, change the settings for the Function Switches.

MIDI Error!!

●MIDI data is not being received correctly. (Press **EXIT** to return to the original screen.)

☐ Check connections made with the external MIDI device (the device connected to the R-5's MIDI IN).

2. Troubleshooting

[Instruments]

No sound produced

The level is set to 0.

- ☞ Set level to an appropriate value. (p. 106)

Output Assignment is set to “MULTI 1 - 4”.

- ☞ When the Multi Output jacks are specified, no sound is output from the Stereo Output jacks. (p. 96)

REST is assigned to a Pad Key.

- ☞ There is no sound data in instrument #68, REST. (p. 166)

Sound is too low

The level setting is low.

- ☞ Raise the level to an appropriate value. (p. 106)

The top of the Pad Keys are being pressed.

- ☞ The Pad Keys should be pressed nearer to the bottom.

The Sensitivity Curve setting is inappropriate.

- ☞ Change the Sensitivity Curve. (p. 97)

Sound is strange

The Sound Parameter settings are inappropriate.

- ☞ Change the Sound Parameters (p. 94), or initialize the Sound Parameters. (p. 125)

The Performance Parameter settings are inappropriate.

- ☞ Change the Performance Parameters (p. 102), or clear the Performance Parameters. (p. 126)

Sound volume does not change when the strength the Pad Keys are hit is changed.

The Sensitivity Curve in the Sound Parameters is set to 7 or 8.

- ☞ Change the Sensitivity Curve. (p. 97)

Sound does not change even though the Sound or Performance Parameters are changed.

- ☞ When the total value of the settings for the Sound Parameters and Performance Parameters combined exceeds the allowable range, no change can be obtained with higher values. Also, even though values are within the allowable range, with certain types of instruments or parameters no change can be obtained.

After using Output Assignment in the Sound Parameters to change pan, there is still no change in the orientation.

When Pan has been set for the Performance Parameters or Sequence parameters, the settings for the Sound Parameters are ignored.

- ☞ Set Pan using the Sequence Parameters (p. 58) for play of a rhythm pattern, and using the Performance Parameters (p. 102) when tapping the Pad Keys to play.

The same instrument sounds no matter which Pad Key is pressed.

It has been set to Multi Assign.

- ☞ Press **MULTI** to release Multi-Assign.

Pad Banks cannot be changed.

It has been set to Multi Assign.

- ☞ Press **MULTI** to release Multi-Assign.

[Rhythm Patterns]

Play doesn't start when **START/STOP is pressed.**

The Sync mode is set to either "TAPE" or "MIDI".

- ☞ Set the Sync mode to "INTERNAL". (p. 134)

The sound of an instrument in a previously created rhythm pattern has changed.

The Sound Parameters have been changed.

- ☞ When changes are made in the Sound Parameters it affects the instruments in all other rhythm patterns.

The Swing effect is not obtained.

Swing Delay is set to 0.

- ☞ Set Swing Delay to an appropriate value. (p. 56)

The setting for Swing Point is inappropriate.

- ☞ Reset the Swing Point. (p. 56)

The unit is set to the Real-time Write or Step Write modes.

- ☞ The Swing effect cannot be obtained while writing patterns.

Real-time Write cannot be performed.

You have the Real-time Edit screen.

- ☞ Press **PAGE** to get the Real-time Write screen.

[Feel Patches]**No change in sound when Feel Patch is assigned.**

The Groove and Random Factor Switches are set to "OFF".

- ☞ Set the Groove and Random Factor Switches to "ON". (p. 111)

The instrument selected with Instrument Select is not used in the rhythm pattern.

- ☞ Make change in Instrument Select. (p. 111)

The Instrument Switch is at "OFF".

- ☞ Set the Instrument Switch to "ON". (p. 112)

The unit is set to the Real-time Write or Step Write modes.

- ☞ The effect of a Feel Patch cannot be obtained while writing patterns.

In the Song Play mode, the Program Change Switch (Function Switch) is at "ON".

- ☞ Set the Program Change Switch to "OFF". (p. 149)

Even when the Instrument Switch is set to "OFF", the corresponding instrument's sound still changes.

- ☞ Check to make sure that you have not specified the same instrument a number of times using Instrument Select. (p.111)

[Songs]

Play doesn't start when **START/STOP** is pressed.

There is no data in the song currently selected.

- ☞ Select a song containing data, or perform Song Write.

The Initial Level is set to 0.

- ☞ Increase Initial Level to an appropriate value. (p. 79)

The Sync mode is set to either "TAPE" or "MIDI".

- ☞ Set the Sync mode to "INTERNAL". (p. 134)

When a song finishes, another one starts playing automatically.

Setting has been made for Song Chain.

- ☞ Remove the Song Chain. (p. 77)

When play of a song is started, the tempo changes.

A setting for Initial Tempo has been made for the song.

- ☞ Set Initial Tempo to "OFF". (p. 79)

When play of a song is started, the level changes.

A setting for Initial Level has been made for the song.

- ☞ Change the setting for Initial Level. (p. 79)

[MIDI]

(When the R-5 is the slave)

No sound is produced.

The MIDI channels do not match.

- ☞ Set the channels so they match. (p. 141,146)

Note Numbers for instruments have not been set properly.

- ☞ Change the Note Numbers. (p. 143)

The Channel Message Switch is set to "OFF".

- ☞ Set the Channel Message Switch to "ON". (p. 148)

No sound is produced by the Performance Section.

The Receive channel of the Performance Section is set to the same channel as the Instrument Section.

- ☞ Set different numbers for the Receive channel of the Performance Section and the Instrument Section. (p. 141,146)

Only one instrument can be sounded.

The MIDI data is being received on the Receive channel for the Performance Section.

- ☞ Set to the Instrument Section's Receive channel. (p. 141)

Sounds mute partway through.

The Note Off Switch is set to "ON".

- ☞ Set the Note Off Switch to "OFF". (p. 141)

The orientation does not change.

The Pan Switch is set to "OFF".

- ☞ Set the Pan Switch to "ON". (p. 149)

When the Pan Switch is set to "ON", any Pan assigned to other Control Changes is disabled.

While using a sequencer's performance data to play the R-5, an R-5 song starts together with it.

The Sync mode is set to MIDI".

- ☞ Set the Sync mode to "INTERNAL". (p. 134)

Exclusive Messages are not received.

The Basic channels do not match.

- ☞ Set the Basic channels so they match. On the R-5, the Basic channel is the Instrument Section's Receive channel. (p. 141)

The Exclusive Switch is set to "OFF".

- ☞ Set the Exclusive Switch to "ON". (p. 150)

(When the R-5 is the master)

No sounds play.

The MIDI channels do not match.

☞ Match the MIDI channels. (p. 142)

Note Numbers for instruments have not been set properly.

☞ Change the Note Numbers. (p. 143)

The Channel Message switch is set to "OFF".

☞ Set the Channel Message switch to "ON". (p. 148)

[Others]

The metronome does not sound.

The metronome level is set to 0.

☞ Raise the level of the metronome. (p. 33)

The metronome mode is set to "OFF".

☞ Set the mode to "REC ON". (p. 33)

The Output for the metronome is set to Multi Output.

☞ Set the Output to Stereo Output. (p. 33)

The metronome stops partway through.

The Metronome Mode is set to "EMPTY".

☞ Set the mode to "REC ON". (p. 33)

The flam effect is not obtained.

The Flam Interval is set to 0.

☞ Set the Flam Interval to an appropriate value. (p. 34)

The setting for Flam Ratio is inappropriate.

☞ Change the Flam Ratio. (p. 34)

Roll cannot be used in play.

The Sync mode is set to either "MIDI" or "TAPE".

☞ Set the Sync mode to "INTERNAL". (p. 134)

3. Blank Chart

[Sound Parameters and Note Numbers]

INST #	INSTRUMENT NAME	PITCH	DECAY	NUANCE	OUTPUT ASSIGN	ASSIGN TYPE	SENSITIVITY CURVE	NOTE #
1	DRY KICK 1		:					
2	DRY KICK 2		:					
3	WOOD KICK		:					
4	DOUBLE HEAD KICK 1		:					
5	DOUBLE HEAD KICK 2		:					
6	SOLID KICK		:					
7	ROOM AMBIENT KICK 1		:					
8	ROOM AMBIENT KICK 2		:					
9	MONDO KICK		:					
10	ELECTRONIC KICK		:					
11	WOOD SNARE		:					
12	OPEN SNARE		:					
13	TIGHT SNARE		:					
14	FAT SNARE		:					
15	IMPACT SNARE		:					
16	JAZZ SNARE		:					
17	OUCH! SNARE		:					
18	REVERB SNARE		:					
19	RIM SHOT SNARE 1		:					
20	RIM SHOT SNARE 2		:					
21	RIM SHOT SNARE 3		:					
22	ELECTRONIC SNARE		:					
23	BRUSH HIT SNARE		:					
24	BRUSH ROLL SNARE		:					
25	SIDE STICK		:					
26	DRY TOM 1		:					

INST #	INSTRUMENT NAME	PITCH	DECAY	NUANCE	OUTPUT ASSIGN	ASSIGN TYPE	SENSITIVITY CURVE	NOTE #
27	DRY TOM 2		:					
28	DRY TOM 3		:					
29	ROOM AMBIENT TOM 1		:					
30	ROOM AMBIENT TOM 2		:					
31	ROOM AMBIENT TOM 3		:					
32	ELECTRONIC TOM 1		:					
33	ELECTRONIC TOM 2		:					
34	ELECTRONIC TOM 3		:					
35	JAZZ TOM 1		:					
36	JAZZ TOM 2		:					
37	JAZZ TOM 3		:					
38	FX TOM		:					
39	CLOSED HI-HAT		:					
40	OPEN HI-HAT		:					
41	PEDAL CLOSED HI-HAT		:					
42	CRASH CYMBAL		:					
43	MALLET CRASH CYMBAL		:					
44	RIDE CYMBAL		:					
45	RIDE BELL CYMBAL		:					
46	RIDE CYMBAL BELL		:					
47	808 HAND CLAP		:					
48	TIMBALE		:					
49	CLAVES		:					
50	CABASA		:					
51	COWBELL		:					
52	TAMBOURINE		:					

INST #	INSTRUMENT NAME	PITCH	DECAY	NUANCE	OUTPUT ASSIGN	ASSIGN TYPE	SENSITIVITY CURVE	NOTE #
53	SHAKER		:					
54	MUTE HIGH CONGA		:					
55	SLAP HIGH CONGA		:					
56	OPEN LOW CONGA		:					
57	AGOGO		:					
58	WHISTLE		:					
59	BONGO		:					
60	CAN		:					
61	SURDO		:					
62	BLAST		:					
63	BACK SNARE		:					
64	BACK CYMBAL		:					
65	FINGER BASS		:					
66	SLAP BASS		:					
67	ACOUSTIC BASS		:					
68	REST		:					

COPY INST #	SOURCE INSTRUMENT		PITCH	DECAY	NUANCE	OUTPUT ASSIGN	ASSIGN TYPE	SENSITIVITY CURVE	NOTE #
	INST #	NAME							
1				:					
2				:					
3				:					
4				:					
5				:					
6				:					
7				:					
8				:					
9				:					
10				:					
11				:					
12				:					
13				:					
14				:					
15				:					
16				:					
17				:					
18				:					
19				:					
20				:					
21				:					
22				:					
23				:					
24				:					
25				:					
26				:					

【Instrument Assignment and Performance Parameters】

Instrument Assign

PAD BANK :

1	2	3	4
5	6	7	8
9	10	11	12
13	14	15	16

Performance Parameter

Pad Key #	Pitch	Decay	Nuance	Pan
1				
2				
3				
4				
5				
6				
7				
8				
9				
10				
11				
12				
13				
14				
15				
16				

【Song Data】

Part #	Data	Part #	Data	Part #	Data	Part #	Data

4. Instrument List

INST #	DISPLAY	INSTRUMENT NAME	COMMENT
* 1	DRY_K1	DRY KICK 1	Close miking sound
* 2	DRY_K2	DRY KICK 2	Close miking sound
* 3	WOOD_K	WOOD KICK	Close miking sound
* 4	DBL_K1	DOUBLE HEAD KICK 1	
* 5	DBL_K2	DOUBLE HEAD KICK 2	
* 6	SOLID	SOLID KICK	
* 7	ROOMK1	ROOM AMBIENT KICK 1	With large room ambience
* 8	ROOMK2	ROOM AMBIENT KICK 2	With large room ambience
* 9	MONDO	MONDO KICK	
* 10	ELE_K	ELECTRONIC KICK	
* 11	WOOD_S	WOOD SNARE	Close miking sound (8 inch snare)
* 12	OPEN_S	OPEN SNARE	Close miking sound
* 13	TIGHT	TIGHT SNARE	Close miking sound (5 inch snare)
* 14	FAT_S	FAT SNARE	
* 15	IMPC_S	IMPACT SNARE	With ambience
* 16	JAZZ_S	JAZZ SNARE	
* 17	OUCH_S	OUCH! SNARE	With Reverb effect
* 18	RVB_S	REVERB SNARE	With Reverb effect
* 19	RIM_S1	RIM SHOT SNARE 1	Close miking sound
* 20	RIM_S2	RIM SHOT SNARE 2	With ambience
* 21	RIM_S3	RIM SHOT SNARE 3	
* 22	ELE_S	ELECTRONIC SNARE	
* 23	BR_HIT	BRUSH HIT SNARE	
24	BR_ROL	BRUSH ROLL SNARE	
25	SIDSTK	SIDE STICK	
* 26	DRY_T1	DRY TOM 1	Close miking sound
* 27	DRY_T2	DRY TOM 2	Close miking sound
* 28	DRY_T3	DRY TOM 3	Close miking sound
* 29	ROOMT1	ROOM AMBIENT TOM 1	With large room ambience
* 30	ROOMT2	ROOM AMBIENT TOM 2	With large room ambience
* 31	ROOMT3	ROOM AMBIENT TOM 3	With large room ambience
* 32	ELE_T1	ELECTRONIC TOM 1	
* 33	ELE_T2	ELECTRONIC TOM 2	
* 34	ELE_T3	ELECTRONIC TOM 3	
* 35	JAZZT1	JAZZ TOM 1	
* 36	JAZZT2	JAZZ TOM 2	
* 37	JAZZT3	JAZZ TOM 3	
* 38	FX_T	FX TOM	
** 39	CLSD_H	CLOSED HI-HAT	
** 40	OPEN_H	OPEN HI-HAT	

INST #	DISPLAY	INSTRUMENT NAME	COMMENT
41	PDAL_H	PEDAL CLOSED HI-HAT	
42	CRSH_C	CRASH CYMBAL	
** 43	MLLT_C	MALLET CRASH CYMBAL	Can be used for rolling with mallet
** 44	RIDE_C	RIDE CYMBAL	
** 45	RDBL_C	RIDE BELL CYMBAL	
46	BELL_C	RIDE CYMBAL BELL	
47	808CLP	808 HAND CLAP	Handclap of the TR-808
48	TIMBAL	TIMBALE	
49	CLAVES	CLAVES	
50	CABASA	CABASA	
51	COWBEL	COWBELL	
52	TAMBRN	TAMBOURINE	
53	SHAKER	SHAKER	
54	MUT_CG	MUTE HIGH CONGA	
55	SLP_CG	SLAP HIGH CONGA	
56	OPN_CG	OPEN LOW CONGA	
57	AGOGO	AGOGO	
58	WHISTL	WHISTLE	
59	BONGO	BONGO	
** 60	CAN	CAN	
* 61	SURDO	SURDO	
** 62	BLAST	BLAST	
** 63	BACK_S	BACK SNARE	Reverse of RVB_S (INST # 18)
64	BACK_C	BACK CYMBAL	Reverse of CRSH_S (INST # 42)
* 65	FING_B	FINGER BASS	
* 66	SLAP_B	SLAP BASS	
* 67	ACO_B	ACOUSTIC BASS	
68	REST	REST	No sound (for mute or choke)

[Copy Instruments: Default Settings]

COPY INST #	SOURCE INSTRUMENT		COMMENT
	INST #	NAME	
* 1	28	DRY TOM 3	
* 2	31	ROOM AMBIENT TOM 3	
* 3	34	ELECTRONIC TOM 3	
* 4	37	JAZZ TOM 3	
* 5	38	FX TOM	
* 6	38	FX TOM	
** 7	39	CLOSED HI-HAT	Harder than CLOSED HI-HAT
** 8	39	CLOSED HI-HAT	Similar to CLOSED HI-HAT, but hit at a position Closer to the edge
** 9	40	OPEN HI-HAT	Can be used as halfopen
** 10	40	OPEN HI-HAT	Open sound similar to bell
11	42	CRASH CYMBAL	
12	42	CRASH CYMBAL	Muted with a hand immediately after hit
13	42	CRASH CYMBAL	Splash Cymbal
14	47	808 HAND CLAP	
15	48	TIMBALE	
16	50	CABASA	
17	51	COWBELL	
18	56	OPEN LOW CONGA	
19	57	AGOGO	
20	59	BONGO	
** 21	40	OPEN HI-HAT	
22	58	WHISTLE	
23	49	CLAVES	Wood Block
24	47	808 HAND CLAP	Gun Shot
25	53	SHAKER	
* 26	66	SLAP BASS	

5. Preset Patterns

PATTERN #	DISPLAY	PATTERN NAME	COMMENT
00	8BEAT1	8BEAT1	Rhythm Pattern with no accent
01	8BEAT2	8BEAT2	Rhythm Pattern with no accent
02	8BEAT3	8BEAT3	
03	8BEAT4	8BEAT4	
04	16BEAT1	16BEAT1	Rhythm Pattern with no accent
05	16BEAT2	16BEAT2	Rhythm Pattern with no accent
06	DISCO1	DISCO1	
07	DISCO2	DISCO2	
08	SLOWROCK	SLOW ROCK	Appropriate tempo is about ♩ = 85
09	SHUFFLE1	SHUFFLE1	Rhythm Pattern with no accent
10	SHUFFLE2	SHUFFLE2	Rhythm Pattern with no accent
11	FUNKY1	FUNKY1	
12	FUNKY2	FUNKY2	
13	FUNKY3	FUNKY3	
14	OLDIES1	OLDIES1	Appropriate tempo is about ♩ = 90
15	OLDIES2	OLDIES2	Appropriate tempo is about ♩ = 180
16	OLDIES3	OLDIES3	
17	METAL1	METAL1	
18	METAL2	METAL2	
19	SWING1	SWING1	Rhythm Pattern with no accent
20	SWING2	SWING2	
21	SWING3	SWING3	
22	BOSANOVA	BOSSA NOVA	
23	MAMBO	MAMBO	
24	MERENGUE	MERENGUE	
25	RHUMBA	RHUMBA	
26	BEGUINE	BEGUINE	
27	SAMBA	SAMBA	
28	SALSA	SALSA	
29	TANGO	TANGO	
30	REGGAE	REGGAE	
31	COUNT	COUNT	

6. Pad Banks: Default Settings

Pad Bank A

() = INST #

(42) CRASH CYMBAL	(79) COPY11	(46) RIDE CYMBAL BELL	(44) RIDE CYMBAL
(26) DRY TOM 1	(27) DRY TOM 2	(28) DRY TOM 3	(69) COPY01
(25) SIDE STICK	(19) RIM SHOT SNARE 1	(39) CLOSED HI-HAT	(40) OPEN HI-HAT
(01) DRY KICK 1	(14) FAT SNARE	(41) PEDAL CLOSED HI-HAT	(47) 808 HAND CLAP

Pad Bank B

(42) CRASH CYMBAL	(79) COPY11	(46) RIDE CYMBAL BELL	(44) RIDE CYMBAL
(29) ROOM AMBIENT TOM 1	(30) ROOM AMBIENT TOM 2	(31) ROOM AMBIENT TOM 3	(70) COPY02
(63) BACK SNARE	(17) OUCH! SNARE	(76) COPY08	(77) COPY09
(07) ROOM AMBIENT KICK 1	(18) REVERB SNARE	(41) PEDAL CLOSED HI-HAT	(51) COWBELL

Pad Bank C

(42) CRASH CYMBAL 1	(79) COPY11	(46) RIDE CYMBAL BELL	(44) RIDE CYMBAL
(32) ELECTRONIC TOM 1	(33) ELECTRONIC TOM 2	(34) ELECTRONIC TOM 3	(71) COPY03
(64) BACK CYMBAL	(62) BLAST	(39) CLOSED HI-HAT	(40) OPEN HI-HAT
(10) ELECTRONIC KICK	(22) ELECTRONIC SNARE	(41) PEDAL CLOSED HI-HAT	(82) COPY14

Pad Bank D

(42) CRASH CYMBAL	(79) COPY11	(46) RIDE CYMBAL BELL	(44) RIDE CYMBAL
(35) JAZZ TOM 1	(36) JAZZ TOM 2	(37) JAZZ TOM 3	(72) COPY04
(25) SIDE STICK	(23) BRUSH HIT SNARE	(39) CLOSED HI-HAT	(40) OPEN HI-HAT
(03) WOOD KICK	(16) JAZZ SNARE	(41) PEDAL CLOSED HI-HAT	(24) BRUSH ROLL SNARE

Pad Bank E

(83) COPY15	(48) TIMBALE	(57) AGOGO	(87) COPY19
(56) OPEN LOW CONGA	(86) COPY18	(55) SLAP HIGH CONGA	(54) MUTE HIGH CONGA
(52) TAMBOURINE	(58) WHISTLE	(88) COPY20	(59) BONGO
(91) COPY23	(49) CLAVES	(50) CABASA	(53) SHAKER

7. Sound Parameters: Default Settings

INST #	DISPLAY	INSTRUMENT NAME	PITCH	DECAY	NUANCE	OUTPUT ASSIGN	ASSIGN TYPE	SENSITIVITY CURVE
1	DRY_K1	DRY KICK 1	0	4:19	8	CENTER	POLY	2
2	DRY_K2	DRY KICK 2	0	20:12	8	CENTER	POLY	2
3	WOOD_K	WOOD KICK	0	16:14	8	CENTER	POLY	2
4	DBL_K1	DOUBLE HEAD KICK 1	0	19:13	8	CENTER	POLY	2
5	DBL_K2	DOUBLE HEAD KICK 2	0	25:12	8	CENTER	POLY	2
6	SOLID	SOLID KICK	0	7: 7	8	CENTER	POLY	2
7	ROOMK1	ROOM AMBIENT KICK 1	0	24:20	8	CENTER	POLY	2
8	ROOMK2	ROOM AMBIENT KICK 2	0	24:24	8	CENTER	POLY	2
9	MONDO	MONDO KICK	0	20:23	8	CENTER	POLY	2
10	ELE_K	ELECTRONIC KICK	0	8:18	8	CENTER	POLY	2
11	WOOD_S	WOOD SNARE	0	19:14	8	CENTER	POLY	2
12	OPEN_S	OPEN SNARE	0	27:14	8	CENTER	POLY	2
13	TIGHT	TIGHT SNARE	0	19:14	8	CENTER	POLY	2
14	FAT_S	FAT SNARE	0	22:15	8	CENTER	POLY	2
15	IMPC_S	IMPACT SNARE	0	23:16	8	CENTER	POLY	2
16	JAZZ_S	JAZZ SNARE	0	19:19	8	CENTER	POLY	2
17	OUCH_S	OUCH! SNARE	0	20:16	8	CENTER	POLY	2
18	RVB_S	REVERB SNARE	0	35:33	8	CENTER	POLY	2
19	RIM_S1	RIM SHOT SNARE 1	0	16:13	8	CENTER	POLY	2
20	RIM_S2	RIM SHOT SNARE 2	0	21:17	8	CENTER	POLY	2
21	RIM_S3	RIM SHOT SNARE 3	0	16:15	8	CENTER	POLY	2
22	ELE_S	ELECTRONIC SNARE	0	20:18	8	CENTER	POLY	2
23	BR_HIT	BRUSH HIT SNARE	0	20:20	8	CENTER	POLY	2
24	BR_ROL	BRUSH ROLL SNARE	0	40:--	--	CENTER	POLY	2
25	SIDSTK	SIDE STICK	0	10:--	--	CENTER	POLY	2
26	DRY_T1	DRY TOM 1	0	30:35	8	RIGHT3	POLY	2
27	DRY_T2	DRY TOM 2	0	29:33	8	RIGHT1	POLY	2
28	DRY_T3	DRY TOM 3	0	28:30	8	LEFT 1	POLY	2
29	ROOMT1	ROOM AMBIENT TOM 1	0	34:33	8	RIGHT3	POLY	2
30	ROOMT2	ROOM AMBIENT TOM 2	0	33:31	8	RIGHT1	POLY	2
31	ROOMT3	ROOM AMBIENT TOM 3	0	32:29	8	LEFT 1	POLY	2
32	ELE_T1	ELECTRONIC TOM 1	0	22:30	8	RIGHT3	POLY	2
33	ELE_T2	ELECTRONIC TOM 2	0	22:30	8	RIGHT1	POLY	2
34	ELE_T3	ELECTRONIC TOM 3	0	22:30	8	LEFT 1	POLY	2

INST #	DISPLAY	INSTRUMENT NAME	PITCH	DECAY	NUANCE	OUTPUT ASSIGN	ASSIGN TYPE	SENSITIVITY CURVE
35	JAZZT1	JAZZ TOM 1	0	33:33	8	RIGHT3	POLY	2
36	JAZZT2	JAZZ TOM 2	0	32:31	8	RIGHT1	POLY	2
37	JAZZT3	JAZZ TOM 3	0	31:29	8	LEFT 1	POLY	2
38	FX_T	FX TOM	0	22:30	8	RIGHT3	POLY	2
39	CLSD_H	CLOSED HIHAT	0	12:12	8	LEFT 1	EXC1	2
40	OPEN_H	OPEN HIHAT	0	35:40	8	LEFT 1	EXC1	2
41	PDAL_H	PEDAL CLOSED HIHAT	0	15:--	--	LEFT 1	EXC1	2
42	CRSH_H	CRASH CYMBAL	0	55:--	--	LEFT 2	POLY	2
43	MLLT_C	MALLET CRASH CYMBAL	0	60:60	5	LEFT 1	POLY	2
44	RIDE_C	RIDE CYMBAL	0	50:50	8	RIGHT2	POLY	2
45	RDBL_C	RIDE BELL CYMBAL	0	50:50	8	RIGHT2	POLY	2
46	BELL_C	RIDE CYMBAL BELL	0	50:--	--	RIGHT2	POLY	2
47	808CLP	808 HAND CLAP	0	23:--	--	RIGHT1	POLY	2
48	TIMBAL	TIMBALE	0	24:--	--	CENTER	POLY	2
49	CLAVES	CLAVES	0	9:--	--	CENTER	MONO	2
50	CABASA	CABASA	0	8:--	--	RIGHT2	POLY	2
51	COWBEL	COWBELL	0	12:--	--	LEFT 2	MONO	2
52	TAMBRN	TAMBOURINE	0	21:--	--	LEFT 1	POLY	2
53	SHAKER	SHAKER	0	12:--	--	LEFT 2	MONO	2
54	MUT_CG	MUTE HIGH CONGA	0	10:--	--	RIGHT1	POLY	2
55	SLP_CG	SLAP HIGH CONGA	0	20:--	--	RIGHT1	POLY	2
56	OPN_CG	OPEN LOW CONGA	0	29:--	--	CENTER	POLY	2
57	AGOGO	AGOGO	0	20:--	--	RIGHT2	POLY	2
58	WHISTL	WHISTLE	0	7:--	--	LEFT 2	EXC2	2
59	BONGO	BONGO	0	14:--	--	LEFT 1	MONO	2
60	CAN	CAN	0	20:30	8	RIGHT3	POLY	2
61	SURDO	SURDO	0	33:28	8	RIGHT3	POLY	2
62	BLAST	BLAST	0	20:35	8	LEFT 1	POLY	2
63	BACK_S	BACK SNARE	0	0: 0	8	LEFT 1	POLY	2
64	BACK_C	BACK CYMBAL	0	0:--	--	RIGHT1	POLY	2
65	FING_B	FINGER BASS	0	3:40	8	CENTER	EXC8	2
66	SLAP_B	SLAP BASS	0	8:40	8	CENTER	EXC8	2
67	ACO_B	ACOUSTIC BASS	0	3:40	8	CENTER	EXC8	2
68	REST	REST	0	0:--	--	CENTER	EXC8	2

COPY INST #	SOURCE INST #	PITCH	DECAY	NUANCE	OUTPUT ASSIGN	ASSIGN TYPE	SENSITIVITY CURVE
1	28	+ 300	27:27	8	LEFT 3	POLY	2
2	31	+ 400	31:27	8	LEFT 3	POLY	2
3	34	+ 700	22:30	8	LEFT 3	POLY	2
4	37	+ 500	30:27	8	LEFT 3	POLY	2
5	38	+ 500	22:30	8	RIGHT1	POLY	2
6	38	+ 1000	20:30	8	LEFT 1	POLY	2
7	39	0	10:12	15	LEFT 1	EXC1	2
8	39	0	20:20	0	LEFT 1	EXC1	2
9	40	0	20:20	0	LEFT 1	EXC1	2
10	40	0	45:40	15	LEFT 1	EXC1	2
11	42	+ 110	55:--	--	RIGHT2	POLY	2
12	42	0	14:--	--	LEFT 2	POLY	2
13	42	+ 900	22:--	--	RIGHT1	POLY	2
14	47	- 200	12:--	--	RIGHT1	POLY	2
15	48	- 700	26:--	--	LEFT 1	POLY	2
16	50	+ 500	8:--	--	RIGHT3	POLY	2
17	51	- 500	16:--	--	LEFT 3	MONO	2
18	56	+ 660	29:--	--	RIGHT1	POLY	2
19	57	+ 700	20:--	--	RIGHT3	POLY	2
20	59	- 360	12:--	--	LEFT 2	MONO	2
21	40	- 1200	50:10	15	LEFT 3	POLY	2
22	58	- 2200	10:--	--	RIGHT2	POLY	2
23	49	- 1500	9:--	--	LEFT 2	MONO	2
24	47	- 1950	60:--	--	CENTER	POLY	2
25	53	- 3600	70:--	--	CENTER	POLY	2
26	66	0	8:40	8	CENTER	POLY	2

8. Note Numbers: Default Settings

INSTRUMENT NAME (INST #)	NOTE
OFF	97
OFF	96
OFF	95
OFF	94
COPY03 (71)	93
OFF	92
ELE T3 (34)	91
COPY07 (75)	90
ELE T2 (33)	89
WOOD S (11)	88
IMPC S (15)	87
OPEN S (12)	86
WOOD K (03)	85
ELE K (10)	84
OFF	83
COPY23 (91)	82
OFF	81
OFF	80
OFF	79
OFF	78
OFF	77
BR ROL (24)	76
BR HIT (23)	75
CLAVES (49)	74
OFF	73
OFF	72
OFF	71
WHISTL (58)	70
OFF	69
CABASA (50)	68
AGOGO (57)	67
COPY19 (87)	66
COPY15 (83)	65
TIMBAL (48)	64
OPN CG (56)	63
COPY18 (86)	62
MUT CG (54)	61
COPY20 (88)	60
BONGO (59)	59
OFF	58
ELE S (22)	57
COPY12 (80)	56
COWBEL (51)	55
COPY13 (81)	54
TAMBRN (52)	53
BELL C (46)	52
OFF	51
RIDE C (44)	50
COPY02 (70)	49
CRSH C (42)	48
COPY01 (69)	47
ROOMT3 (31)	46
OPEN H (40)	45
DRY T3 (28)	44
PDAL H (41)	43
ROOMT2 (30)	42
CLSD H (39)	41
DRY T2 (27)	40
RVB S (18)	39
808CLP (47)	38
FAT S (14)	37
SIDSTK (25)	36
ROOMK1 (07)	35
DRY K1 (01)	34
OFF	34

C1

C6

C5

C4

C3

C2

Roland Exclusive Messages

1 Data Format for Exclusive Messages

Roland's MIDI implementation uses the following data format for all exclusive messages (type IV):

Byte	Description
F0H	Exclusive status
41H	Manufacturer ID (Roland)
DEV	Device ID
MDL	Model ID
CMD	Command ID
[BODY]	Main data
F7H	End of exclusive

MIDI status : F0H, F7H

An exclusive message must be flanked by a pair of status codes, starting with a Manufacturer-ID immediately after F0H (MIDI version 1.0).

Manufacturer-ID : 41H

The Manufacturer-ID identifies the manufacturer of a MIDI instrument that triggers an exclusive message. Value 41H represents Roland's Manufacturer-ID.

Device-ID : DEV

The Device-ID contains a unique value that identifies the individual device in the multiple implementation of MIDI instruments. It is usually set to 00H - 0FH, a value smaller by one than that of a basic channel, but value 00H - 1FH may be used for a device with multiple basic channels.

Model-ID : MDL

The Model-ID contains a value that uniquely identifies one model from another. Different models, however, may share an identical Model-ID if they handle similar data.

The Model-ID format may contain 00H in one or more places to provide an extended data field. The following are examples of valid Model-IDs, each representing a unique model:

01H
02H
03H
00H, 01H
00H, 02H
00H, 00H, 01H

Command-ID : CMD

The Command-ID indicates the function of an exclusive message. The Command-ID format may contain 00H in one or more places to provide an extended data field. The following are examples of valid Command-IDs, each representing a unique function:

01H
02H
03H
00H, 01H
00H, 02H
00H, 00H, 01H

Main data : BODY

This field contains a message to be exchanged across an interface. The exact data size and contents will vary with the Model-ID and Command-ID.

2 Address-mapped Data Transfer

Address mapping is a technique for transferring messages conforming to the data format given in Section 1. It assigns a series of memory-resident records -- waveform and tone data, switch status, and parameters, for example -- to specific locations in a machine-dependent address space, thereby allowing access to data residing at the address a message specifies.

Address-mapped data transfer is therefore independent of models and data categories. This technique allows use of two different transfer procedures: one-way transfer and handshake transfer.

One-way transfer procedure (See Section 3 for details.)

This procedure is suited for the transfer of a small amount of data. It sends out an exclusive message completely independent of a receiving device status.

Connection Diagram

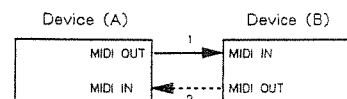

Connection at point 2 is essential for "Request data" procedures. (See Section 3.)

Handshake-transfer procedure (See Section 4 for details.)

This procedure initiates a predetermined transfer sequence (handshaking) across the interface before data transfer takes place. Handshaking ensures that reliability and transfer speed are high enough to handle a large amount of data.

Connection Diagram

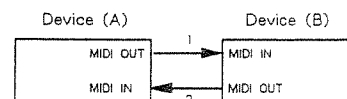

Connection at points 1 and 2 is essential.

Notes on the above two procedures

- * There are separate Command-IDs for different transfer procedures.
- * Devices A and B cannot exchange data unless they use the same transfer procedure, share identical Device-ID and Model-ID, and are ready for communication.

3 One-way Transfer Procedure

This procedure sends out data all the way until it stops and is used when the messages are so short that answerbacks need not be checked.

For long messages, however, the receiving device must acquire each message in time with the transfer sequence, which inserts intervals of at least 20 milliseconds in between.

Types of Messages

Message	Command ID
Request data 1	RQ1 (11H)
Data set 1	DT1 (12H)

Request data # 1 : RQ1 (11H)

This message is sent out when there is a need to acquire data from a device at the other end of the interface. It contains data for the address and size that specify designation and length, respectively, of data required.

On receiving an RQ1 message, the remote device checks its memory for the data address and size that satisfy the request.

If it finds them and is ready for communication, the device will transmit a "Data set 1 (DT1)" message, which contains the requested data. Otherwise, the device will send out nothing.

Byte	Description
F0H	Exclusive status
41H	Manufacturer ID (Roland)
DEV	Device ID
MDL	Model ID
11H	Command ID
aaH	Address MSB
⋮	⋮
⋮	LSB
ssH	Size MSB
⋮	⋮
⋮	LSB
sum	Check sum
F7H	End of exclusive

- *The size of the requested data does not indicate the number of bytes that will make up a DT1 message, but represents the address fields where the requested data resides.
- *Some models are subject to limitations in data format used for a single transaction. Requested data, for example, may have a limit in length or must be divided into predetermined address fields before it is exchanged across the interface.
- *The same number of bytes comprises address and size data, which, however, vary with the Model - ID.
- *The error checking process uses a checksum that provides a bit pattern where the least significant 7 bits are zero when values for an address, size, and that checksum are summed.

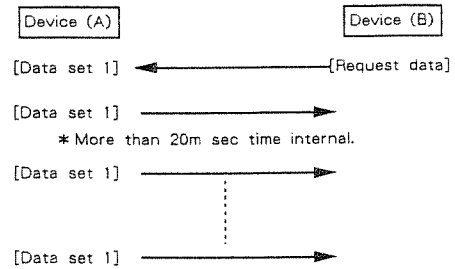

4 Handshake - Transfer Procedure

Handshaking is an interactive process where two devices exchange error checking signals before a message transaction takes place, thereby increasing data reliability. Unlike one-way transfer that inserts a pause between message transactions, handshake transfer allows much speedier transactions because data transfer starts once the receiving device returns a ready signal.

When it comes to handling large amounts of data -- sampler waveforms and synthesizer tones over the entire range, for example -- across a MIDI interface, handshaking transfer is more efficient than one-way transfer.

Data set 1 : DT1 (12H)

This message corresponds to the actual data transfer process. Because every byte in the data is assigned a unique address, a DT1 message can convey the starting address of one or more data as well as a series of data formatted in an address-dependent order.

The MIDI standards inhibit non-real time messages from interrupting an exclusive one. This fact is inconvenient for the devices that support a "soft-through" mechanism. To maintain compatibility with such devices, Roland has limited the DT1 to 256 bytes so that an excessively long message is sent out in separate segments.

Byte	Description
F0H	Exclusive
41H	Manufacturer ID (Roland)
DEV	Device ID
MDL	Model ID
12H	Command ID
aaH	Address MSB
⋮	⋮
⋮	⋮
ddH	Data
⋮	⋮
⋮	⋮
sum	Check sum
F7H	End of exclusive

Types of Messages

Message	Command ID
Want to send data	WSD (40H)
Request data	RQD (41H)
Data set	DAT (42H)
Acknowledge	ACK (43H)
End of data	EOD (45H)
Communication error	ERR (4EH)
Rejection	RJC (4FH)

- *A DT1 message is capable of providing only the valid data among those specified by an RQ1 message.
- *Some models are subject to limitations in data format used for a single transaction. Requested data, for example, may have a limit in length or must be divided into predetermined address fields before it is exchanged across the interface.
- *The number of bytes comprising address data varies from one Model - ID to another.
- *The error checking process uses a checksum that provides a bit pattern where the least significant 7 bits are zero when values for an address, size, and that checksum are summed.

Want to send data : WSD (40H)

This message is sent out when data must be sent to a device at the other end of the interface. It contains data for the address and size that specify designation and length, respectively, of the data to be sent.

On receiving a WSD message, the remote device checks its memory for the specified data address and size which will satisfy the request. If it finds them and is ready for communication, the device will return an "Acknowledge (ACK)" message. Otherwise, it will return a "Rejection (RJC)" message.

Example of Message Transactions

- Device A sending data to Device B
Transfer of a DT1 message is all that takes place.

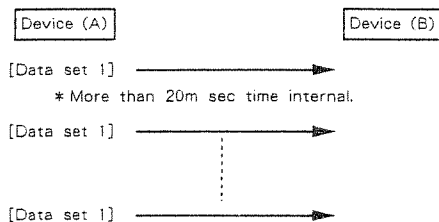

- Device B requesting data from Device A
Device B sends an RQ1 message to Device A. Checking the message, Device A sends a DT1 message back to Device B.

Byte	Description
F0H	Exclusive status
41H	Manufacturer ID (Roland)
DEV	Device ID
MDL	Model ID
40H	Command ID
aaH	Address MSB
⋮	⋮
⋮	⋮
ssH	Size MSB
⋮	⋮
⋮	⋮
sum	Check sum
F7H	End of exclusive

- *The size of the data to be sent does not indicate the number of bytes that make up a "Data set (DAT)" message, but represents the address fields where the data should reside.
- *Some models are subject to limitations in data format used for a single transaction. Requested data, for example, may have a limit in length or must be divided into predetermined address fields before it is exchanged across the interface.
- *The same number of bytes comprises address and size data, which, however, vary with the Model - ID.
- *The error checking process uses a checksum that provides a bit pattern where the least significant 7 bits are zero when values for an address, size, and that checksum are summed.

Request data : RQD (41H)

This message is sent out when there is a need to acquire data from a device at the other end of the interface. It contains data for the address and size that specify designation and length, respectively, of data required.

On receiving an RQD message, the remote device checks its memory for the data address and size which satisfy the request. If it finds them and is ready for communication, the device will transmit a "Data set (DAT)" message, which contains the requested data. Otherwise, it will return a "Rejection (RJC)" message.

Byte	Description
F0H	Exclusive status
41H	Manufacturer ID (Roland)
DEV	Device ID
MDL	Model ID
41H	Command ID
aaH	Address MSB
⋮	⋮
	LSB
ssH	Size MSB
⋮	⋮
	LSB
sum	Check sum
F7H	End of exclusive

- *The size of the requested data does not indicate the number of bytes that make up a "Data set (DAT)" message, but represents the address fields where the requested data resides.
- *Some models are subject to limitations in data format used for a single transaction. Requested data, for example, may have a limit in length or must be divided into predetermined address fields before it is exchanged across the interface.
- *The same number of bytes comprises address and size data, which, however, vary with the Model - ID.
- *The error checking process uses a checksum that provides a bit pattern where the least significant 7 bits are zero when values for an address, size, and that checksum are summed.

Data set : DAT (42H)

This message corresponds to the actual data transfer process. Because every byte in the data is assigned a unique address, the message can convey the starting address of one or more data as well as a series of data formatted in an address - dependent order.

Although the MIDI standards inhibit non - real time messages from interrupting an exclusive one, some devices support a "soft - through" mechanism for such interrupts. To maintain compatibility with such devices, Roland has limited the DAT to 256 bytes so that an excessively long message is sent out in separate segments.

Byte	Description
F0H	Exclusive status
41H	Manufacturer ID (Roland)
DEV	Device ID
MDL	Model ID
42H	Command ID
aaH	Address MSB
⋮	⋮
	LSB
ddH	Data
⋮	⋮
sum	Check sum
F7H	End of exclusive

- *A DAT message is capable of providing only the valid data among those specified by an RQD or WSD message.
- *Some models are subject to limitations in data format used for a single transaction. Requested data, for example, may have a limit in length or must be divided into predetermined address fields before it is exchanged across the interface.
- *The number of bytes comprising address data varies from one model ID to another.
- *The error checking process uses a checksum that provides a bit pattern where the least significant 7 bits are zero when values for an address, size, and that checksum are summed.

Acknowledge : ACK (43H)

This message is sent out when no error was detected on reception of a WSD, DAT, "End of data (EOD)", or some other message and a requested setup or action is complete. Unless it receives an ACK message, the device at the other end will not proceed to the next operation.

Byte	Description
F0H	Exclusive status
41H	Manufacturer ID (Roland)
DEV	Device ID
MDL	Model ID
43H	Command ID
F7H	End of exclusive

End of data : EOD (45H)

This message is sent out to inform a remote device of the end of a message. Communication, however, will not come to an end unless the remote device returns an ACK message even though an EOD message was transmitted.

Byte	Description
F0H	Exclusive status
41H	Manufacturer ID (Roland)
DEV	Device ID
MDL	Model ID
45H	Command ID
F7H	End of exclusive

Communications error : ERR (4EH)

This message warns the remote device of a communications fault encountered during message transmission due, for example, to a checksum error. An ERR message may be replaced with a "Rejection (RJC)" one, which terminates the current message transaction in midstream.

When it receives an ERR message, the sending device may either attempt to send out the last message a second time or terminate communication by sending out an RJC message.

Byte	Description
F0H	Exclusive status
41H	Manufacturer ID (Roland)
DEV	Device ID
MDL	Model ID
4EH	Command ID
F7H	End of exclusive

Rejection : RJC (4FH)

This message is sent out when there is a need to terminate communication by overriding the current message. An RJC message will be triggered when :

- a WSD or RQD message has specified an illegal data address or size.
- the device is not ready for communication.
- an illegal number of addresses or data has been detected.
- data transfer has been terminated by an operator.
- a communications error has occurred.

An ERR message may be sent out by a device on either side of the interface. Communication must be terminated immediately when either side triggers an ERR message.

Byte	Description
F0H	Exclusive status
41H	Manufacturer ID (Roland)
DEV	Device ID
MDL	Model ID
4FH	Command ID
F7H	End of exclusive

Example of Message Transactions

● Data transfer from device (A) to device (B).

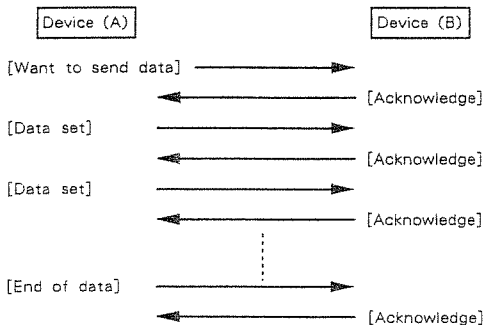

● Device (A) requests and receives data from device (B).

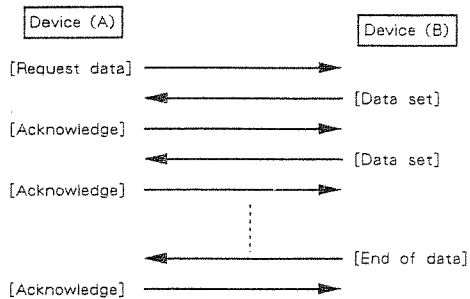

● Error occurs while device (A) is receiving data from device (B).

1) Data transfer from device (A) to device (B).

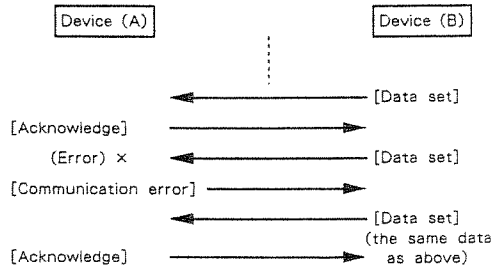

2) Device (B) rejects the data re-transmitted, and quits data transfer.

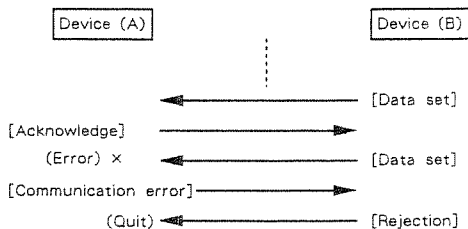

3) Device (A) immediately quits data transfer.

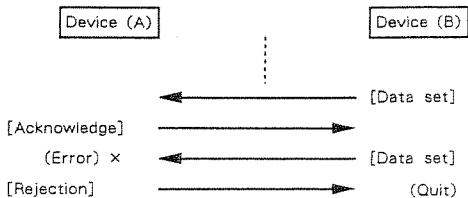

1. TRANSMITTED DATA

Channel Voice Message

Note off

Status	Second	Third
9nH	kkH	00H

kk = Note number 00H - 7FH (0 - 127)
 n = MIDI Channel 0H - FH (1 - 16)

Note on

Status	Second	Third
9nH	kkH	vvH

kk = Note number 00H - 7FH (0 - 127)
 vv = Velocity 01H - 7FH (1 - 127)
 n = MIDI Channel 0H - FH (1 - 16)

Note number (0 - 127 or OFF), and transmitting channel (1 - 16) can be set for each instrument. An instrument whose note number is set at OFF cannot send any Note event.

The period between a Note On and the subsequent Note Off is in the range of 25ms and 50ms. If, however, another note is made on the same instrument before the Note Off for the previous note is issued, a Note Off for the previous note precedes the new Note On.

The R-5 does not transmit a note event if the Function switch is set at CH MESS = OFF.

Control change

Modulation Depth

Status	Second	Third
BnH	01H	vvH
BnH	21H	vvH

General purpose Controller - 1

Status	Second	Third
BnH	10H	vvH
BnH	30H	vvH

General purpose Controller - 2

Status	Second	Third
BnH	11H	vvH
BnH	31H	vvH

General purpose Controller - 3

Status	Second	Third
BnH	12H	vvH
BnH	32H	vvH

General purpose Controller - 4

Status	Second	Third
BnH	13H	vvH
BnH	33H	vvH

General purpose Controller - 5

Status	Second	Third
BnH	50H	vvH

General purpose Controller - 6

Status	Second	Third
BnH	51H	vvH

General purpose Controller - 7

Status	Second	Third
BnH	52H	vvH

General purpose Controller - 8

Status	Second	Third
BnH	53H	vvH

vv = Performance parameter value 00H - 7FH (0 - 127) *1
 n = MIDI Channel 0H - FH (1 - 16)

Instruments and Performance parameters can be assigned to each of 9 controls (Modulation Depth and General purpose controllers (1-8)).

These 9 controls may be set to have no Performance parameter.

If an instrument has an assigned control number, it is sent with the current performance parameter value which is sent through the Control Change just before the Note On is sent.

Table *1-1 relates Performance Parameter values to those actually transmitted at a Control Change. Since a Performance Pitch value requires 2 bytes for transmission, Control Number 21H, 30H, 31H, 32H or 33H is used as the lower byte. Performance value of Decay, Nuance or Pan can be expressed in 1 byte and does not need such Control Number.

General purpose controllers, 5-8 have no Control Number usable as lower byte and are not used in transmitting Performance Pitch.

No Control Change is transmitted when the Function switch is set at CH MESS = OFF.

*1-1 Control Change Value

parameter	transmitted	received
	- 4800 -> 0400H	0000H-0407H -> - 4800
	- 4790 -> 0410H	0408H-0417H -> - 4790
	- 4780 -> 0420H	0418H-0427H -> - 4780
	:	:
	- 0090 -> 3E70H	3E68H-3E77H -> - 0090
	- 0080 -> 3F00H	3E78H-3F07H -> - 0080
	- 0070 -> 3F10H	3F08H-3F17H -> - 0070
	:	:
pitch	- 0010 -> 3F70H	3F68H-3F77H -> - 0010
	0000 -> 4000H	3F78H-4007H -> 0000
	+ 0010 -> 4010H	4008H-4017H -> + 0010
	:	:
	+ 0070 -> 4070H	4068H-4077H -> + 0070
	+ 0080 -> 4100H	4078H-4107H -> + 0080
	+ 0090 -> 4110H	4108H-4117H -> + 0090
	:	:
	+ 4780 -> 7B60H	7B58H-7B67H -> + 4780
	+ 4790 -> 7B70H	7B68H-7B77H -> + 4790
	+ 4800 -> 7C00H	7B78H-7F77H -> + 4800
	:	:
	- 63 -> 01H	00H -> - 63
	- 62 -> 02H	01H -> - 62
	:	:
decay	- 01 -> 3FH	3FH -> - 01
	00 -> 40H	40H -> 00
	+ 01 -> 41H	41H -> + 01
	:	:
	+ 62 -> 7EH	7EH -> + 62
	+ 63 -> 7FH	7FH -> + 63
	:	:
	- 7 -> 08H	00H-08H -> - 7
	- 6 -> 10H	0CH-13H -> - 6
	- 5 -> 18H	14H-1BH -> - 5
	:	:
nuance	- 1 -> 38H	34H-3BH -> - 1
	0 -> 40H	3CH-43H -> 0
	+ 1 -> 48H	44H-4BH -> + 1
	:	:
	+ 5 -> 68H	64H-6BH -> + 5
	+ 6 -> 70H	6CH-73H -> + 6
	+ 7 -> 78H	74H-7FH -> + 7
	:	:
pan	0 (L3) -> 08H	00H-0FH -> 0 (L3)
	1 (L2) -> 18H	10H-1FH -> 1 (L2)
	2 (L1) -> 28H	20H-2FH -> 2 (L1)
	3 (C) -> 38H	30H-3FH -> 3 (C)
	4 (R1) -> 48H	40H-4FH -> 4 (R1)
	5 (R2) -> 58H	50H-5FH -> 5 (R2)
	6 (R3) -> 68H	60H-6FH -> 6 (R3)
7 (OFF) -> 7FH	70H-7FH -> 7 (OFF)	

System Exclusive message

Status
FOH : System Exclusive
F7H : EOX (End of Exclusive)

With the R-5, the System Exclusive Message can be used to transmit sound parameter of each instrument and Bulk Dump of sequence data, set-up data and one pattern. For details refer to para. 4. Exclusive Communications and "Roland Exclusive Messages".

System common message

Song position pointer

Status Second Third
F2H IH hhH

ll = song position (LSB) 00H - 7FH (0 - 127)
hh = song position (MSB) 00H - 7FH (0 - 127)

Transmitted in one of the following operations:
Song Play mode - measure reposition or measure selection
Pattern Play or Real Time Write mode - bar reposition or bar selection

Song select

Status Second
F3H ssH

ss = song select 00H - 05H (0 - 5)

Transmitted when a Song is selected in Song Play mode.

System Real Time message

Timing Clock

Status
F8H

Transmitted when Sync mode is other than MIDI, even in non-play period.

Start

Status
FAH

Transmitted upon pressing START key for initiating play with Sync mode set at other than MIDI.

Continue

Status
FBH

Transmitted when CONTINUE START is made for initiating play with Sync mode set at other than MIDI.

Stop

Status
FCH

Transmitted when STOP is made with Sync mode set at other than MIDI.

Active Sensing

Status
FEH

Transmitted for checking MIDI connection between R-5 and external equipment.

2. RECOGNIZED RECEIVE DATA (INSTRUMENT SECTION)

Channel Voice Message

Note off

Status Second Third
8nH kkH vvH
9nH kkH 00H

kk = Note number 00H - 7FH (0 - 127)
vv = Velocity ignored
n = MIDI Channel 0H - FH (1 - 16)

Mutes the sounding notes upon receiving a Note Off message if the Function switch is set at NOTE OFF = ON.

Note on

Status Second Third
9nH kkH vvH

kk = Note number 00H - 7FH (0 - 127)
vv = Velocity 01H - 7FH (1 - 127)
n = MIDI Channel 0H - FH (1 - 16)

When the R-5 receives a Note On on the channel assigned to the instrument Section, it sounds the instrument assigned that Note Number.

In the case when one or more instrument has been set to the same Note Number, up to 12 instruments can sound simultaneously; if more than 12 instruments have the same Note Number, priority is given to larger Instrument Numbers.

The R-5 ignores note events if Function switch is set at CH MESS = OFF.

Control change

Panpot

Status Second Third
BnH 0AH vvH

vv = Panpot 00H - 7FH (0 - 127) * 2 - 1
n = MIDI Channel 0H - FH (1 - 16)

When the R-5 receives a PANPOT with the Function switch set at PANPOT = ON: Every time the R-5 receives a Note On on the receiving channel of the Instrument Section, it sounds on the PANPOT position until the Panpot having different value is given.

Refer to Table * 2 - 1 for the relationship between Panpot values and positions of the instrument.

The R-5 does not recognize Panpot if the Function switch is set at CH MESS = OFF or PANPOT = OFF.

* 2 - 1 Control Change Value (Panpot)

Parameter	received
	00H-12H -> 0 (L3)
	13H-24H -> 1 (L2)
	25H-36H -> 2 (L1)
pan	37H-48H -> 3 (C)
	49H-5AH -> 4 (R1)
	5BH-6CH -> 5 (R2)
	6DH-7FH -> 6 (R3)

Modulation Depth

Status Second Third
BnH 01H vvH
BnH 21H vvH

General purpose Controller - 1

Status Second Third
BnH 10H vvH
BnH 30H vvH

General purpose Controller - 2

Status Second Third
BnH 11H vvH
BnH 31H vvH

○ General purpose Controller - 3

Status	Second	Third
BnH	12H	vvH
BnH	32H	vvH

○ General purpose Controller - 4

Status	Second	Third
BnH	13H	vvH
BnH	33H	vvH

○ General purpose Controller - 5

Status	Second	Third
BnH	50H	vvH

○ General purpose Controller - 6

Status	Second	Third
BnH	51H	vvH

○ General purpose Controller - 7

Status	Second	Third
BnH	52H	vvH

○ General purpose Controller - 8

Status	Second	Third
BnH	53H	vvH

vv = Performance parameter value 00H - 7FH (0 - 127) *1 - 1
 n = MIDI Channel 0H - FH (1 - 16)

Instruments and Performance parameters can be assigned to each of 9 controls (Modulation Depth and General purpose controllers (1 - 8)). These 9 controls may be set to have no Performance parameter. (This assignment is in common with that of transmitter.)

When the R-5 receives Modulation Depth or General purpose Controller (1 - 8) on the Receiving Channel of the Instrument Section, it memorizes the value with Control Number.

Upon receiving a Note On, and if an instrument has an assigned Control Number, the R-5 sounds the Performance Parameter which has been converted from the value memorized in the Control Change.

Refer to Table *1 - 1 for relationship between received Control Change values and Performance Parameters.

The R-5 does not recognize Control Change if the Function switch is set at CH MESS = OFF.

● Program change

Status	Second
CnH	ppH

(Pattern mode)
 pp = Program number 00H - 63H (0 - 99)
 n = MIDI Channel 0H - FH (1 - 16)

When the R-5 receives a Program Change on the Basic Channel (Instrument Section receiving channel) in Pattern Play mode with the Function switch set at PROG CHG = ON, it changes the Pattern number to the new number (same as the program number).

(Song Play mode)
 pp = Program number 00H - 07H (0 - 7)
 7FH (127)
 n = MIDI Channel 0H - FH (1 - 16)

When the R-5 receives a Program Change on the Basic Channel (Instrument Section receiving channel) in Song Play mode with the Function switch set at PROG CHG = ON, it changes the Feel Patch number to the new number (same as the program number).

Reception of 7FH (127) has an effect of no-feel patch.

The R-5 ignores Program Change when the Function switch is set at CH MESS = OFF or PROG CHG = OFF.

■ System Exclusive message

Status	Second	Third
FOH		: System Exclusive
F7H		: EOX (End of Exclusive)

With the R-5 the System Exclusive Message can be used to receive Sound Part of each instrument and Bulk Load of Sequence data, Set-up data and one p. For details refer to para. 4. Exclusive Communications and "Roland Exclusive Message". The R-5 ignores Exclusive Message if the Function switch is set at EXCLSV OFF.

■ System common message

● Song position pointer

Status	Second	Third
F2H	llH	hhH

ll = song position (LSB) 00H - 7FH (0 - 127)
 hh = song position (MSB) 00H - 7FH (0 - 127)

Recognized only when the R-5 is in stop with Sync at MIDI. When the R-5 receives Song Position Pointer in Song Play mode it calls the p in the song and when in Pattern Play mode or Real Time Write mode, the p in the pattern.

● Song select

Status	Second
F3H	ssH

ss = song select 00H - 05H (0 - 5)

Recognized only when the R-5 is in stop with Sync at MIDI. When received in Song Play mode, it changes the songs.

■ System Real Time message

● Timing Clock

Status
F8H

Recognized only when the Sync mode is set at MIDI.

● Start

Status
FAH

Recognized only when the Sync mode is set at MIDI.

● Continue

Status
FBH

Recognized only when the Sync mode is set at MIDI.

● Stop

Status
FCH

Recognized only when the Sync mode is set at MIDI.

3. RECOGNIZED RECEIVE DATA (PERFORMANCE SECTION 1-4)

Channel Voice Message

Note off

Status	Second	Third
8nH	kkH	vvH
9nH	kkH	00H

kk = Note number 00H - 7FH (0 - 127)
 vv = Velocity ignored
 n = MIDI Channel 0H - FH (1 - 16)

When the Function switch is set at NOTE OFF = ON, the received Note Off message mutes the sounds being reproduced.

Note on

Status	Second	Third
9nH	kkH	vvH

kk = Note number 00H - 7FH (0 - 127)
 vv = Velocity 01H - 7FH (1 - 127)
 n = MIDI Channel 0H - FH (1 - 16)

All sections can be assigned a channel (1-16) or OFF.
 When the R-5 receives Note On on the MIDI receiving channel of a Performance Section, the instrument allocated to that section will sound.

The Performance parameter to be controlled by Note number can be selected from panel operation for each section. Received Note number will be converted into the Performance Parameter before the instrument is reproduced.

When Instrument Section and Performance Section are set at the same receiving channel, priority is given to the Instrument Section. If more than one Performance Section is set at the same receiving channel, they are reproduced simultaneously.

The R-5 ignores Note event when the Function switch is set at CH MESS = OFF.

Control change

Panpot

Status	Second	Third
BnH	0AH	vvH

vv = Panpot 00H - 7FH (0 - 127) * 2 - 1
 n = MIDI Channel 0H - FH (1 - 16)

When a Panpot is received with the Function switch set at PANPOT = ON, the subsequent Note On's on the same channel cause the instruments to sound on the same position. To change the position Panpot of different value must be issued on that channel. Refer to Fig. *2-1 for Panpot values vs Positions.

Panpot is ignored if the Function switch is set at CH MESS = OFF or PANPOT = OFF.

Modulation Depth

Status	Second	Third
BnH	01H	vvH
BnH	21H	vvH

vv = Performance parameter value 00H - 7FH (0 - 127) * 1 - 1
 n = MIDI Channel 0H - FH (1 - 16)

A Performance Parameter can be assigned to Modulation Depth for each section (No - Control - change - received can also be set).

The R-5, when it receives a Modulation Depth on the receiving channel of a particular Performance Section, memorizes the value for that section.

And it converts this memorized value to generate the Performance Parameter when it reproduces a sound upon receiving a Note On.

Refer to Table *1-1 for relationship between received control change values and performance parameters.

The R-5 does not recognize Control Change if the function switch is set at CH MESS = OFF.

4. EXCLUSIVE COMMUNICATIONS

With the R-5, Exclusive One Way Messages can be used for transferring of sound parameters and bulk dumping/loading of the internal memory.

In Exclusive message, the model ID is expressed by 2CH and device ID by the basic channel number. In actual data, the value of device ID is smaller the basic channel number by 1.

ONE - WAY COMMUNICATIONS

Request Data RQ1 11H

byte	Description
F0H	Exclusive status
41H	Manufactures ID (Roland)
DEV	Device ID
2CH	Model ID (R-5)
11H	Command ID (RQ1)
aaH	Address MSB
aaH	Address
aaH	Address
aaH	Address LSB
ssH	Size MSB
ssH	Size
ssH	Size
ssH	Size LSB
sum	Check sum
F7H	EOX (End of exclusive)

Data set DT1 12H

byte	Description
F0H	Exclusive status
41H	Manufactures ID (Roland)
DEV	Device ID
2CH	Model ID (R-5)
12H	Command ID (DT1)
aaH	Address MSB
aaH	Address
aaH	Address
aaH	Address LSB
ddH	Data
:	:
sum	Check sum
F7H	EOX (End of exclusive)

The R-5 sends parameter (s) by using one way communications in either of the following cases.

1. MIDI Bulk Dump is executed.
(A group of designated parameters are sent.)
2. ENTER key is pressed during Sound Edit.
(The sound parameters of the sound being edited are sent.)

The R-5 receives parameter (s) by using one way communications in the following case.

The R-5's sequencer is stopped and EXCLSV RX of MIDI FUNCTION SW is ON.

Also note that Song data and Pattern data can be received on All songs. All patterns or one pattern basis while the remaining parameters can be received in a unit of mapped one byte.

5. PARAMETER ADDRESS MAP

Addresses are shown in 7-bit hexadecimal

Address	MSB			LSB
Binary	0aaa aaaa	0bbb bbbb	0ccc cccc	0ddd dddd
7-bit hex.	AA	BB	CC	DD

Parameter base address

Start address	Description	
00 00 00 00	Sound Parameter #1	*5-1
00 00 00 0A	Sound Parameter #2	
:	:	
00 00 07 22	Sound Parameter #94	
00 01 00 00	Copy Instrument	*5-2
00 03 00 00	Performance Parameter #A-1	*5-3
00 03 00 08	Performance Parameter #A-2	
:	:	
00 03 00 78	Performance Parameter #A-16	
00 03 01 00	Performance Parameter #B-1	
:	:	
00 03 01 78	Performance Parameter #B-16	
00 03 02 00	Performance Parameter #C-1	
:	:	
00 03 02 78	Performance Parameter #C-16	
00 03 03 00	Performance Parameter #D-1	
:	:	
00 03 03 78	Performance Parameter #D-16	
00 03 04 00	Performance Parameter #E-1	
:	:	
00 03 04 78	Performance Parameter #E-16	
00 03 05 00	Performance Parameter #M-1	
:	:	
00 03 05 78	Performance Parameter #M-16	
00 04 00 00	Feel Patch #0	*5-4
00 04 00 5C	Feel Patch #1	
:	:	
00 04 05 04	Feel Patch #7	
00 05 00 00	Inst Assign	*5-5
00 06 00 00	Level	*5-6
00 07 00 00	MIDI data	*5-7
00 08 00 00	System data	*5-8
01 00 00 00	Song data	*5-9
02 00 00 00	PTN 00 data	*5-10
02 02 00 00	PTN 01 data	
:	:	
03 46 00 00	PTN 99 data	

*5-1 Sound Parameter

Offset address	Description	
00 00	0000 aaaa Pitch data bit3-0	0 - 480
00 01	0000 bbbb : bit7-4	
00 02	0000 000c : bit8	
00 03	0000 000a sign Pitch	0 - 1 (0=plus, 1=minus)
00 04	0aaa aaaa Decay for Partial-1	0 - 127
00 05	0aaa aaaa Decay for Partial-2	0 - 127
00 06	0000 aaaa Nuance	0 - 15
00 07	0000 aaaa Output Assign	0 - 10 (LEFT3-1, CENTER, RIGHT1-3, MULT11-4)
00 08	0000 aaaa Assign Type	0 - 9 (EXC1-8, MONO, POLY)
00 09	0000 0aaa Sensitivity Curve	0 - 7 (1 - 8)
Total size	00 00 00 0A	

*5-2 Copy Instrument

Offset address	Description	
00 00	0aaa aaaa COPY01 Source Inst#	0 - 93
00 01	0aaa aaaa COPY02 Source Inst#	0 - 93
:	:	
00 19	0aaa aaaa COPY26 Source Inst#	0 - 93
Total size	00 00 00 1A	

*5-3 Performance Parameter

Offset address	Description	
00 00	0000 aaaa Pitch data bit3-0	0 - 480
00 01	0000 bbbb : bit7-4	
00 02	0000 000c : bit8	
00 03	0000 000a sign Pitch	0 - 1 (0=plus, 1=minus)
00 04	0aaa aaaa Decay	-63 - +63 *
00 05	0000 aaaa Nuance	-7 - +7 *
00 06	0000 0aaa Pan	0 - 7 (LEFT3, 2, 1, CENTER, RIGHT1, 2, 3, OFF)
00 07	0xxx xxxx dummy (ignored if received)	
Total size	00 00 00 08	

* 2's-complement

*5-4 Feel Patch

Offset address	Description	
00 00	0aaa aaaa inst# for INST1	0 - 93
:	:	
00 07	0aaa aaaa inst# for INST8	0 - 93
00 08	0000 dcba inst sw for INST1	
	a : Velocity	0 - 1 (OFF, ON)
	b : Decay	0 - 1 (OFF, ON)
	c : Pitch	0 - 1 (OFF, ON)
	d : Nuance	0 - 1 (OFF, ON)
00 0F	0000 dcba inst sw for INST8	
	a : Velocity	0 - 1 (OFF, ON)
	b : Decay	0 - 1 (OFF, ON)
	c : Pitch	0 - 1 (OFF, ON)
	d : Nuance	0 - 1 (OFF, ON)
00 10	0000 dcba Random sw	
	a : Velocity	0 - 1 (OFF, ON)
	b : Decay	0 - 1 (OFF, ON)
	c : Pitch	0 - 1 (OFF, ON)
	d : Nuance	0 - 1 (OFF, ON)
00 11	0000 aaaa Random Probability for Velocity	1 - 8
00 12	0000 aaaa Random Probability for Decay	1 - 8
00 13	0000 aaaa Random Probability for Pitch	1 - 8
00 14	0000 aaaa Random Probability for Nuance	1 - 8
00 15	0000 0aaa Random Depth for Velocity	1 - 4
00 16	0000 0aaa Random Depth for Decay	1 - 4
00 17	0000 0aaa Random Depth for Pitch	1 - 4
00 18	0000 0aaa Random Depth for Nuance	1 - 4
00 19	0000 dcba Groove sw	
	a : Velocity	0 - 1 (OFF, ON)
	b : Decay	0 - 1 (OFF, ON)
	c : Pitch	0 - 1 (OFF, ON)
	d : Nuance	0 - 1 (OFF, ON)
00 1A	0000 aaaa Groove Type	1 - 8
00 1B	0000 0aaa Groove Step	1 - 7 (1/4, 1/6, 1/8, 1/12, 1/16, 1/24, 1/32)

00 1C	Groove Velocity offset #1	*5-4-1
:	:	:
00 2A	Groove Velocity offset #8	

00 2C	Groove Decay offset #1	*5-4-1
:	:	:
00 3A	Groove Decay offset #8	

00 3C	Groove Pitch offset #1	*5-4-1
:	:	:
00 4A	Groove Pitch offset #8	

00 4C	Groove Nuance offset #1	*5-4-1
:	:	:
00 5A	Groove Nuance offset #8	

Total size	00 00 00 5C	

* 5 - 4 - 1 Groove offset

Offset address	Description
00 0aaa aaaa	absolute value 0 - 99
01 0000 000a	sign bit 0 - 1 (0=plus, 1=minus)

Total size	00 00 00 02

* 5 - 5 Inst Assign

Offset address	Description
00 00	0aaa aaaa inst# (Pad A-1) 0 - 93
:	:
00 0F	0aaa aaaa inst# (Pad A-16) 0 - 93
00 10	0aaa aaaa inst# (Pad B-1) 0 - 93
:	:
00 1F	0aaa aaaa inst# (Pad B-16) 0 - 93
00 20	0aaa aaaa inst# (Pad C-1) 0 - 93
:	:
00 2F	0aaa aaaa inst# (Pad C-16) 0 - 93
00 30	0aaa aaaa inst# (Pad D-1) 0 - 93
:	:
00 3F	0aaa aaaa inst# (Pad D-16) 0 - 93
00 40	0aaa aaaa inst# (Pad E-1) 0 - 93
:	:
00 4F	0aaa aaaa inst# (Pad E-16) 0 - 93

00 50	0xxx xxxx dummy (ignored if received)
00 51	0xxx xxxx dummy (ignored if received)
00 52	0xxx xxxx dummy (ignored if received)

00 53	0aaa aaaa inst# (Multi) 0 - 93

Total size	00 00 00 54

* 5 - 6 Level

Offset address	Description
00 00	0000 aaaa Level for inst #1 0 - 15
00 01	0000 aaaa Level for inst #2 0 - 15
:	:
00 5D	0000 aaaa Level for inst #94 0 - 15

Total size	00 00 00 5E

* 5 - 7 MIDI data

Offset address	Description
00 00	0000 aaaa Tx Channel for inst #1 0 - 15 (1 - 16)
:	:
00 5D	0000 aaaa Tx Channel for inst #94 0 - 15 (1 - 16)

00 5E	0xxx xxxx	dummy (ignored if received)
:	:	:
00 77	0xxx xxxx	dummy (ignored if received)

00 78	000a aaaa	Rx Channel (Perform Section #1) 0 - 16 (1-16, OFF)
00 79	000a aaaa	Rx Channel (Perform Section #2) 0 - 16 (1-16, OFF)
00 7A	000a aaaa	Rx Channel (Perform Section #3) 0 - 16 (1-16, OFF)
00 7B	000a aaaa	Rx Channel (Perform Section #4) 0 - 16 (1-16, OFF)

00 7C		Note No. for inst #1 *5-7-1
00 7E		Note No. for inst #2
:		:
02 36		Note No. for inst #94

02 38	0xxx xxxx	dummy (ignored if received)
:		:
02 6B	0xxx xxxx	dummy (ignored if received)

02 6C	0000 dcba	Function sw a : CH MESS 0 - 1 (OFF, ON) b : NOTE OFF 0 - 1 (OFF, ON) c : PANPOT 0 - 1 (OFF, ON) d : PROG CHG 0 - 1 (OFF, ON)

02 6D		Control Change Parameter *5-7-2

02 7F		Performance Section #1 *5-7-3
03 05		Performance Section #2
:		:
03 11		Performance Section #4

Total size	00 00 03 17	

* 5 - 7 - 1 Note #

Offset address	Description
00 0aaa aaaa	Note No. 0 - 127
01 0000 000a	ON/OFF sw 0 - 1 (OFF, ON)

Total size	00 00 00 02

* 5 - 7 - 2 Control Change Parameter

Offset address	Description

Modulation	
00 0aaa aaaa	Control inst# 0 - 93
01 0000 0aaa	Control Parameter 0 - 4 (PITCH, DECAY, NUANCE, PAN, OFF)

Controller-1	
02 0aaa aaaa	Control inst# 0 - 93
03 0000 0aaa	Control Parameter 0 - 4 (PITCH, DECAY, NUANCE, PAN, OFF)

Controller-2	
04 0aaa aaaa	Control inst# 0 - 93
05 0000 0aaa	Control Parameter 0 - 4 (PITCH, DECAY, NUANCE, PAN, OFF)

Controller-3	
04 0aaa aaaa	Control inst# 0 - 93
05 0000 0aaa	Control Parameter 0 - 4 (PITCH, DECAY, NUANCE, PAN, OFF)

Controller-4	
04 0aaa aaaa	Control inst# 0 - 93
05 0000 0aaa	Control Parameter 0 - 4 (PITCH, DECAY, NUANCE, PAN, OFF)

Controller-5	
04 0aaa aaaa	Control inst# 0 - 93
05 0000 0aaa	Control Parameter 1 - 4 (DECAY, NUANCE, PAN, OFF)

Controller-6			
04	0aaa aaaa	Control inst#	0 - 93
05	0000 0aaa	Control Parameter	1 - 4 (DECAY, NUANCE, PAN, OFF)
Controller-7			
04	0aaa aaaa	Control inst#	0 - 93
05	0000 0aaa	Control Parameter	1 - 4 (DECAY, NUANCE, PAN, OFF)
Controller-8			
10	0aaa aaaa	Control inst#	0 - 93
11	0000 0aaa	Control Parameter	1 - 4 (DECAY, NUANCE, PAN, OFF)
Total size		00 00 00 12	

*** 5 - 7 - 3 Performance Section**

Offset address	Description
00	0aaa aaaa Control inst# 0 - 93
01	0000 00aa Parameter(Note# Controlled) 0 - 3 (PITCH, DECAY, NUANCE, PAN)
02	0aaa aaaa Center Note# 0 - 127
03	0aaa aaaa Keyboard follow 0 - 99
04	0xxx xxxx dummy (ignored if received)
05	0000 0aaa Parameter(MODUL Controlled) 0 - 4 (PITCH, DECAY, NUANCE, PAN, OFF)
Total size 00 00 00 06	

*** 5 - 8 System data**

Offset address	Description
00 00	0000 00aa Sync mode 0 - 2 (INTERNAL, MIDI, TAPE)
00 01	0000 aaaa ROLL Resolution 1 - 9 (1/4, 1/6, 1/8, 1/12, 1/16, 1/24, 1/32, 1/48, HIGH)
00 02	Metronome set *5-8-1
Total size 00 00 00 06	

*** 5 - 8 - 1 Metronome Set**

Offset address	Description
00	0000 0aaa Interval 1 - 7 (1/4, 1/6, 1/8, 1/12, 1/16, 1/24, 1/32)
01	0000 00aa Mode 0 - 2 (OFF, EMPTY, REC ON)
02	0000 aaaa Level 0 - 15
03	0000 aaaa Output 0 - 10 (LEFT3-1, CENTER, RIGHT1-3, MULTI1-4)
Total size 00 00 00 04	

*** 5 - 9 Song data**

Data included in the area are: Song data, Song name, Song chain and Initial parameters of Songs 0 to 5.
When the data in this area are transmitted from Bulk Dump operation, the size of the data depends upon that of Song data.
If you want to send Data Request to the R-5 in this area, set the address to 01 00 00 00, and the size to 01 00 00 00.
The R-5 ignores Data Requests which designate different address or size.
No data in this area can be transferred in a unit of one byte.

*** 5 - 10 Pattern data**

Data included in the area are: Rhythm data, Time signature, Number of meas Flam interval, Flam ratio, Swing point, Swing delay and Feel patch number in pattern.
When the data in this area are transmitted from Bulk Dump operation, the size of data depends upon the number of notes.
If you want to send Data Request to the R-5 in this area, set the address and size as follows.
one pattern address = the address of the pattern
size = 00 02 00 00
all pattern address = 02 00 00 00
size = 01 48 00 00
The R-5 ignores Data Requests which designate different address or size.
No data in the area can be received in a unit of one byte.

Address	Block	Sub block	Reference
00 00 00 00	Sound Param.	Inst #1	5-1
		Inst #2	
		:	
		Inst #93	
		Inst #94	
00 01 00 00	Copy Instrument		5-2
00 03 00 00	Perform Param.	A-1	5-3
		A-2	
		:	
		M-15	
		M-16	
00 04 00 00	Feel Patch	#0	5-4
		#1	
		:	
		#6	
		#7	
00 05 00 00	Inst Assign		5-5
00 06 00 00	Level	Inst #1	5-6
		Inst #2	
		:	
		Inst #93	
		Inst #94	
00 07 00 00	MIDI data		5-7
00 08 00 00	System data		5-8
01 00 00 00	Song data		5-9
02 00 00 00	Pattern data	PTN 00	5-10
		PTN 01	
		:	
		PTN 98	
		PTN 99	

Function ...		Transmitted	Recognized	Remarks
Basic Channel	Default Changed	1 - 16 1 - 16	1 - 16 1 - 16	Memorized (Non - volatile)
Mode	Default Messages Altered	Mode 3 × *****	Mode 3 ×	
Note Number	True Voice	0 - 127 * 2 *****	0 - 127 * 2	Assignable to each instrument
Velocity	Note ON Note OFF	* 1 9n v = 1 - 127 × 9n v = 0	* 1 9b v = 1 - 127 ×	n = Inst Ch * 3 b = Basic Ch
After Touch	Key's Ch's	× ×	× ×	
Pitch Bender		×	×	
Control Change	1, 33	* 1	* 1	Modulation
	10	×	* 1	Panpot
	16, 48	* 1	* 1	General purpose control - 1
	17, 49	* 1	* 1	General purpose control - 2
	18, 50	* 1	* 1	General purpose control - 3
	19, 51	* 1	* 1	General purpose control - 4
	80	* 1	* 1	General purpose control - 5
	81	* 1	* 1	General purpose control - 6
	82	* 1	* 1	General purpose control - 7
	83	* 1	* 1	General purpose control - 8
Prog Change	True #	× *****	* 1	
System Exclusive		○	* 1	
System Common	Song Pos Song Sel Tune	○ SYNC = INT/TAPE ○ SYNC = INT/TAPE ×	○ SYNC = MIDI ○ SYNC = MIDI ×	0 - 5
System Real Time	Clock Commands	○ SYNC = INT/TAPE ○ SYNC = INT/TAPE	○ SYNC = MIDI ○ SYNC = MIDI	
Aux Message	Local ON/OFF All Notes OFF Active Sense Reset	× × ○ ×	× × × ×	
Notes		* 1 Can be set to ○ or × manually and memorized. * 2 Can be changed manually and memorized. * 3 Transmit channel of each instrument can be changed to 1 to 16 manually.		

Function ...		Transmitted	Recognized	Remarks
Basic Channel	Default Changed	× ×	OFF OFF, 1 - 16 * 2	Memorized (Non - volatile)
Mode	Default Messages Altered	× × *****	Mode 3 ×	
Note Number	True Voice	× *****	0 - 127	
Velocity	Note ON Note OFF	× ×	○ 9n v = 1 - 127 ×	n = Section Ch
After Touch	Key's Ch's	× ×	× ×	
Pitch Bender		×	×	
Control Change	1, 33	×	* 1	Modulation Panpot
	10	×	* 1	
Prog Change	True #	× *****	×	
System Exclusive		×	×	
System Common	Song Pos	×	×	
	Song Sel	×	×	
	Tune	×	×	
System Real Time	Clock	×	×	
	Commands	×	×	
Aux Message	Local ON/OFF	×	×	
	All Notes OFF	×	×	
	Active Sense	×	×	
	Reset	×	×	

Notes

* 1 Can be set to ○ or × manually and memorized.
(for each Performance Section)

* 2 If channel is set to OFF, R - 8 cannot recognize any message.

SPECIFICATIONS

R-5: Human Rhythm Composer

●Sound Sources

Internal Instrument Voices : 68 types

Copy Instrument Voices : 26 types

(Sound Parameters)

Pitch: ± 4 octaves (in 10-cent units)

Decay: 0 to 127

Nuance: 0 to 15

Output Assignment: Multi Out 1 - 4/ Stereo Out (7 orientations)

Assign Type: MONO/POLY/EXC 1 to 8

Sensitivity Curve: 1 to 8

●Rhythm Patterns

Preset Patterns: 32

Programmable Patterns:

100 available

Max. of 99 measures per pattern

Total of 2,600 notes for 100 patterns

Storable Data:

Velocity/Pitch/Decay/Nuance/Pan

●Songs

6 available (max. of 999 measures per song)

Storable data:

Initial Tempo/Initial Level/Rhythm patterns/

Repeats/Tempo Changes/Level Change/Label

●Feel Patches: 8 available

●External Memory: Audio-use recording tape

●Timing Resolution of Sound Production :

1/96 note

●Tempo: 40 to 250 beats per minute

●Display

LCD display (16 characters, 2 lines)

Tempo Indicator/ Pattern Indicator/ Song Indicator

●Control Section

[Front Panel]

Value Slider

Volume Slider

Song Button

Pattern Button

MIDI Button

Instrument Assign Button

Tape Button

Utility Button

Sound Button

Performance Button

Feel Button

Pad Bank Button

Multi Button

Condition Button

Scope Button

Cursor Buttons (◀ / ▶)

Page Button

Tempo button

Level Button

Numerical Keys

EXIT Button

ENTER Button

Parameter Up/Down Buttons

Parameter Select Button

Start/Stop Button

Roll Button

Flam Button

Shift Button

Pad Keys 1 to 16 (equipped with touch sensitivity)

[Rear Panel]

Power Switch

● **Output Jacks**

Multi Output Jacks 1 to 4

Stereo Output Jacks (R/L (MONO))

Headphone Jack

● **Connectors**

Start/Stop Jack

Tape In Jack

Tape Out Jack

MIDI Connectors (IN/OUT/THRU)

AC Adapter Socket (± 10 V)

● **Dimensions**

340 (W) × 215(D) × 60(H) mm

13 - 3/8" × 8 - 7/16" × 2 - 3/8"

● **Weight** : 1.85 Kg

4lb 1oz

● **Power Consumption:**

117V : 7.5W (ACH-120)

220/240V : 5.5W (ACH-220, 240E/A)

● **Accessories**

Specially dedicated AC adaptor (ACH Series)

Owner's Manual

R-5 Guidebook

Quick References: Modes/ Instruments/ Sound

Data Flow chart/ Parameters

MIDI Guidebook

Warranty Information

List of Service Stations

● **Options**

Pedal Switch (DP-2)

Footswitch (FS-5U)

* The specifications for this product are subject to change without prior notice in the interest of improvements.

Index to Terms used

[A]

Align	104
All Pattern Clear	124
All Song Clear	123
Assign Type	96
Available Memory	124

[B]

Basic Channel	141
Basic Screen	37
Bulk Dump	151

[C]

Center Note Number	146
Channel Message	148
Channel Message Switch	148
Clear	125
Condition Function	122
Continue Play	76
Control Change	144
Copy Instrument	100

[D]

Decay	58, 94, 102
-------	-------------

[D]

Edit Mode	17
Edit Screen	37
Error Messages	170

[E]

Exclusive Message	151
Exclusive Switch	150

[F]

Feel Edit Mode	18
Feel Patch	108
Flam	31, 34, 41
Flam Interval	34
Flam Ratio	34
Function Switch	148

[G]

Groove	108
Groove Select	110
Groove Step	110
Groove Switch	111
Groove Type	110

[I]

Index Search Function	45
Initial Level	79
Initial Tempo	79
Initialize	125
Instrument Assign	88
Instrument Assign Mode	18
Instrument Change	48
Instrument Section	140, 141
Instrument Select	111
Instrument Switch	112

[K]

Keyboard Follower	146
-------------------	-----

[L]

Label	73
Level	106
Level Change	72
Load	133

[M]

Main Mode	17
Menu Screen	19
Metronome	33
MIDI Mode	18
Mode	17
Multi Assign	90

[N]

Note Message	142
Note Number	143
Note Off	148
Note Off Switch	148
Nuance	58, 95, 102

[O]

Output Assign 96

[P]

Pad Bank 88

Pan 59, 96, 102

Pan Switch 149

Part 66

Part Copy 82

Part Delete 80

Part Insert 81

Pattern Append 49

Pattern Copy 54

Pattern Extract 50

Pattern Merge 52

Pattern Mode 18

Pattern Write 26

Performance Edit Mode 18

Performance Parameters 92, 102

Performance Section 140, 146

Pitch 58, 94, 102

Preset Pattern 47

Probability 111

Program Change 149

Program Change Switch 149

Programmable Pattern 26

[Q]

Quantize 28

[R]

Random Depth 112

Random Factor 109

Random Factor Switch 111

Real-time Edit 60

Real-time Write 27

Receive Channel 141, 146

Reframe 53

Repeat 70

Roll 31, 34

[S]

Save 130

Scope Edit Screen 37

Scope Function 43, 62

Scope Screen 37

Scope Step 43

Search Label 74, 78

Sensitivity Curve 97

Sequence Parameter 58, 93

Shift Functions 21

Song 66

Song Chain 77

Song Clear 85

Song Copy 83

Song Edit 80

Song Mode 18

Song Name 84

Song Write 67

Sound Edit Mode 18

Sound Parameter 92, 94

Step 36

Step Edit 61

Step Write 36

Swing 56

Swing Delay 56

Swing Point 56

Sync Mode 134

[T]

Tape Interface 130

Tape Mode 18

Tape Sync 136

Tempo 30

Tempo Change 71

Transmit Channel 142

[U]

Utility 123

Utility Mode 18

[V]

Velocity 58

Verify 132

[W]

Write Screen 37

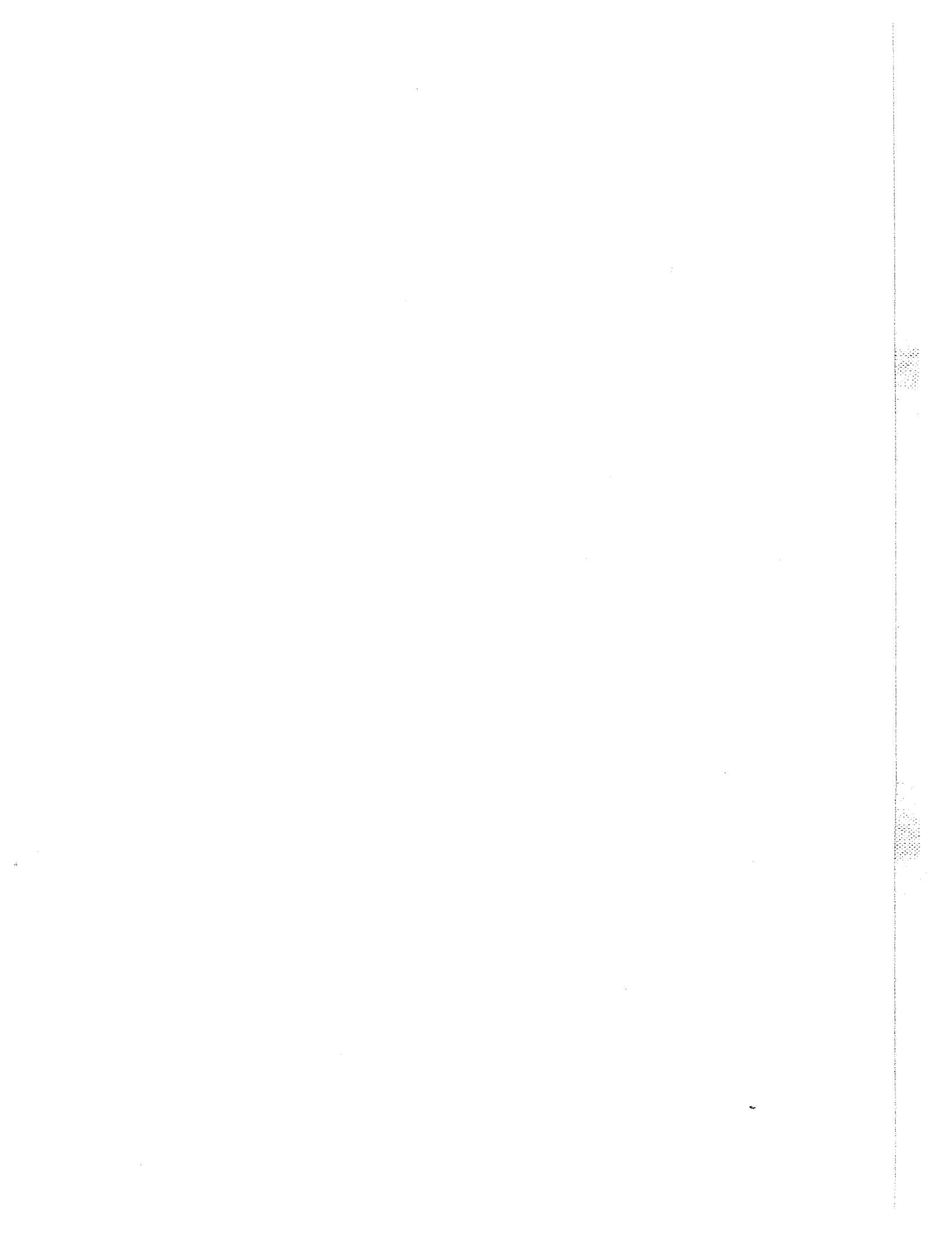

INFORMATION

When you need repair service, call your local Roland Service Station or the authorized Roland distributor in your country as shown below.

U. S. A.

Roland Corporation US
7200 Dominion Circle
Los Angeles, CA.
90040-3647, U. S. A.
☎ (213)685 - 5141

CANADA

Roland Canada Music Ltd.
(Head Office)
5480 Parkwood
Richmond B. C., V6V 2M4
CANADA
☎ (604)270 - 6626

Roland Canada Music Ltd.
9425 Transcanadienne
Service Rd. N., St Laurent,
Quebec H4S 1V3,
CANADA
☎ (514)335 - 2009

Roland Canada Music Ltd.
346 Watline Avenue,
Mississauga, Ontario L4Z
1X2, CANADA
☎ (416)890 - 6488

AUSTRALIA

Roland Corporation
(Australia) Pty. Ltd.
(Head Office)
38 Campbell Avenue
Dee Why West, NSW 2099
AUSTRALIA
☎ (02)982 - 8266

Roland Corporation
(Australia) Pty. Ltd.
(Melbourne Office)
50 Garden Street
South Yarra, Victoria 3141
AUSTRALIA
☎ (03)241 - 1254

UNITED KINGDOM

Roland(U.K.) Ltd.
Rye Close
Ancells Business Park
Fleet, Hampshire GU13
8UY, UNITED KINGDOM
☎ 0252 - 816181

Roland(U.K.) Ltd.,
Swansea Office
Atlantic Close, Swansea
Enterprise Park, Swansea,
West Glamorgan SA79FJ,
UNITED KINGDOM
☎ (0792)700 - 139

ITALY

Roland Italy S. p. A.
Viale delle Industrie 8
20020 ARESE MILANO
ITALY
☎ 02 - 93581311

SPAIN

Roland Electronics
de España, S. A.
Calle Bolivia 239
08020 Barcelona, SPAIN
☎ 93 - 308 - 1000

GERMANY

Roland Elektronische
Musikinstrumente
Handelsgesellschaft mbH.
Oststrasse 96, 2000
Norderstedt, GERMANY
☎ 040/52 60 090

FRANCE

Musikengro
102 Avenue Jean-Jaures
69007 Lyon Cedex 07
FRANCE
☎ (7)858 - 54 60

Musikengro (Paris Office)
Centre Region Parisienne
41 rue Charles-Fourier,
94400 Vitry s/Seine
FRANCE
☎ (1)4680 86 62

BELGIUM/ HOLLAND/ LUXEMBOURG

Roland Benelux N. V.
Houtstraat 1
B-2260 Oevel-Westerlo
BELGIUM
☎ (0032)14 - 575811

DENMARK

Roland Scandinavia A/S
Langebrogade 6
Box 1937
DK-1023 Copenhagen K.
DENMARK
☎ 31 - 95 31 11

SWEDEN

Roland Scandinavia A/S
DanvikCenter 28 A, 2 tr.
S-131 30 Nacka
SWEDEN
☎ 08 - 702 00 20

NORWAY

Roland Scandinavia
Avd. Norge
Lilleakerveien 2
Postboks 95 Lilleaker
N-0216 Oslo 2
NORWAY
☎ 02 - 73 00 74

FINLAND

Fazer Musik Inc.
Länsituulentie
POB 169
SF-02101 Espoo
FINLAND
☎ 0 - 43 50 11

NEW ZEALAND

Roland Corporation
(NZ) Ltd.
97 Mt. Eden Road, Mt.
Eden, Auckland 3,
NEW ZEALAND
☎ (09)3098 - 715

SWITZERLAND

Musitronic AG
Gerberstrasse 5, CH-4410
Liestal, SWITZERLAND
☎ 061/921 16 15

Roland CK (Switzerland)
AG
Postfach/Hauptstrasse 21
CH-4456 Tenniken
SWITZERLAND
☎ 061/98 60 55
Repair Service by
Musitronic AG

AUSTRIA

E. Dematte & Co.
Neu-Rum Siemens-
Strasse 4
A-6021 Innsbruck Box 591
AUSTRIA
☎ (0512)63 451

GREECE

V. Dimitriadis & Co. Ltd.
2 Phidiou Str., GR 106 78
Athens, GREECE
☎ 1 - 3620130

PORTUGAL

Casa Caius Instrumentos
Musicais Lda.
Rua de Santa Catarina 131
Porto, PORTUGAL
☎ 02 - 38 44 56

HUNGARY

Intermusica Ltd.
Warehouse Area 'DEPO'
Torokbalint, Budapest
HUNGARY
☎ (1)1868905

ISRAEL

D.J.A. International Ltd.
25 Pinsker St., Tel Aviv
ISRAEL
☎ 972 - 3 - 5283015

CYPRUS

Radex Sound Equipment
Ltd.
17 Panteli Katelari Str.
P.O.Box 2046, Nicosia
CYPRUS
☎ 453426, 466423

TURKEY

Barkat Sanayi ve Ticaret
Siraselviler Cad. 86/6
Taksim Istanbul, TURKEY
☎ 149 93 24

EGYPT

Al Fanny Trading Office
9, Ebn Hagar Askalany
Street, Ard El Golf,
Heliopolis, Cairo, EGYPT
☎ 2917803 - 665918

BRAZIL

Roland Brasil Ltda.
R. Alvarenga 591
CEP-05509 Sao Paulo
BRAZIL
☎ (011)813 - 7967
Repair Service for Roland
and Rhodes products

Oliver do Brasil S.A.
Instrumentos Musicais
Av. Ceci. No.578 Centro
Empresarial Tambore
Barueri SP CEP 06400
BRAZIL
☎ (011)709 - 1267
Repair Service for BOSS
products

MEXICO

Case Veerkamp, s.a. de c.v.
Mesones No. 21
Col. Centro
C.P. 06080 Mexico, D.F.
MEXICO
☎ (5)709 - 3716

La Casa Wagner de
Guadalajara s.a. de c.v.
Av. Corona No. 202 S.J.
C.P.44100
Guadalajara, Jalisco
MEXICO
☎ (36)13 - 1414

ARGENTINA

Netto S.A.
Venezuela 1433
1095 Buenos Aires
ARGENTINA
☎ 37 - 1632

HONG KONG

Tom Lee Music Co., Ltd.
Service Division
22-32 Pun Shan Street,
Tsuen Wan, New
Territories, HONG KONG
☎ 415 - 0911

KOREA

Cosmos Corporation
Service Station
261 2nd Floor Nak-Won
arcade
Jong-Ro ku, Seoul, KOREA
☎ (02) 742 8844

SINGAPORE

Swee Lee Company
Bras Basah Complex
#03-23 Singapore 0178
SINGAPORE
☎ 3367886

THAILAND

Theera Music Co., Ltd.
330 Verng Nakorn Kasem,
Soi 2, Bangkok 10100,
THAILAND
☎ 2248821

MALAYSIA

Syarikat Bentley
No.142, Jaian Bukit
Bintang 55100 Kuala
Lumpur, MALAYSIA
☎ 2421288

INDONESIA

PT Galestra Inti
Kompleks Perkantoran
Duta Merlin Blok C/59
Jl. Gajah mada No.3-5
Jakarta 10130
INDONESIA
☎ (021) 354604, 354606

TAIWAN

Siruba Enterprise(Taiwan)
Co., LTD.
Room. 5, 9fl. No. 112
Chung Shan N.Road Sec.2
Taipei, TAIWAN, R.O.C.
☎ (02)5364546

SOUTH AFRICA

That Other Music
Shop(PTY) LTD.
256 Bree Street,
Johannesburg 2001
Republic of South Africa
☎ 337 - 6573

Paul Bothner(PTY) LTD.
17 Werdmuller Centre
Claremont 7700
Republic of South Africa
☎ 021 - 64 - 4030

